



SOLVAY

asking more from chemistry®

Radel® | Veradel® | Acudel®

Radel® PPSU, Veradel® PESU & Acudel® modified PPSU

Design Guide

**SPECIALTY
POLYMERS**

Table of Contents

Chemistry	8	Deflection Temperature Under Load	25
Chemical Structure – Property Relationships	8	Testing variables	25
Material Selection	9	Heat deflection temperature comparisons	26
Approvals	11	Thermal Expansion Coefficient	26
Food Contact	11	Thermal Conductivity	27
ISO 10993	11	Specific Heat	27
National Sanitation Foundation	11	UL-94	27
NSF standard 51: Food equipment materials	11	Oxygen index	27
NSF standard 61: Drinking water system components – health effects	11	Self-ignition temperature	27
International Water Contact Standards	12	Smoke density	28
French ACS Sanitary Conformity Certificate	12	Thermal Stability	28
Water byelaws scheme – United Kingdom	12	Thermogravimetric analysis	28
German Federal Health Office	12	Thermal aging	29
Underwriters Laboratories	12	UL relative thermal index	29
Short-Term Properties	13	Electrical Properties	30
Typical Property Tables	13	Dielectric Strength	30
Tensile Properties	13	Volume Resistivity	30
Stress-Strain Curves	16	Dielectric Constant	30
Compressive Properties	19	Dissipation Factor	30
Shear Properties	19	UL-746A Short-Term Properties	30
Notched Izod	20	High-voltage, low-current dry arc resistance	30
Notch sensitivity	21	Comparative Tracking Index (CTI)	30
Tensile impact	21	High-Voltage Arc – Tracking Rate (HVTR)	30
Poisson's Ratio	21	Hot Wire Ignition (HWI)	30
Wear Resistance	21	High-Current Arc Ignition (HAI)	30
Long-Term Properties	22	Environmental Resistance	32
Creep	22	Hydrolytic Stability	32
Creep modulus	22	Steam sterilization analysis	32
Isochronous stress-strain curves	23	Chemical Resistance	33
Fatigue	23	Radel® PPSU chemical resistance	33
Thermal Properties	24	Stress crack resistance	35
Glass Transition Temperature	24	Radiation Resistance	35
Mechanical Property Changes	24	Physical Properties	39
Classification of thermoplastic resins	24	Density	39
Temperature effects on modulus	25	Water Absorption	39
Temperature effects on tensile strength	25	Mechanical Design	40
		Stress Levels	40
		Stress-Strain Calculations	40
		Design limits	43
		Stress concentrations	43

Designing for Injection Molding	44	Extruded Product Types	56
Wall Thickness	44	Wire	56
Wall Thickness Variation	44	Film	56
Draft Angle	44	Sheet	56
Ribs	45	Pipe and tubing	56
Coring	45	Start-Up, Shut-Down, and Purging	57
Bosses	46	Start-up procedure	57
Drying	47	Shut-down procedure	57
Rheology	48	Purging	57
Melt Processing Parameters	50	Machining	58
Injection Molding	50	Drilling and Tapping	58
Injection Molding Equipment	50	Sawing	58
Screw design	50	Turning	58
Screw tips and check valves	50	Milling and Routing	58
Nozzles	50	Finishing and Decorating	58
Molds	50	Painting	58
Draft and ejection	50	Electroplating	58
Gates	50	Hot Stamping	59
Venting	50	Printing	59
Mold temperature control	51	Vacuum Metallizing	59
Machine Settings	51	Cathode Sputtering	59
Injection molding temperatures	51	Flame/Arc Spraying	59
Mold temperatures	51	Assembly and Joining	60
Barrel temperatures	51	Ultrasonic Bonding	60
Residence time in the barrel	51	Spin Welding	60
Molding Process	52	Adhesive Bonding	60
Feed characteristics	52	Mechanical Fasteners	61
Back pressure	52	Molded-in threads	62
Screw speed	52	Threaded inserts	62
Injection rate and venting	52	Self-tapping screws	63
Demolding	52	Ultrasonic Inserts	64
Shrinkage	52	Snap-Fits	64
Resin Flow Characteristics	53		
Health and Safety Considerations	54		
Measuring Residual Stress	54		
Predrying	55		
Extrusion Temperatures	55		
Screw Design Recommendations	55		
Die Design	55		
Procedure for Residual Stress Determination	55		

This design guide contains specific information about Radel® polyphenylsulfone (PPSU), Veradel® polyethersulfone (PESU), and Acudel® modified polyphenylsulfone (PPSU). The Udel® PSU Design Guide is the primary reference for information on Udel® polysulfone.

The purpose of this guide is to provide design engineers with specific information needed to make effective use of these materials. In addition to short-term mechanical, thermal, electrical, and physical property data, this guide includes information about long-term properties, such as creep, fatigue, and thermal stability; resistance to chemicals and other environmental factors; and information about agency approvals. Also included are recommendations for processing these materials, designing parts, and performing secondary operations.

This document concentrates on the standard grades of Radel® PPSU, Veradel® PESU and Acudel® mod. PPSU resins. Specialty grades, such as the Radel® PPSU materials specially formulated to meet the stringent safety requirements of the commercial aircraft industry, are outside the scope of this manual. For information on the other product lines or the specialty grades of Radel® polyphenylsulfone, please consult our website at www.solvay.com or contact your sales representative.

Radel® PPSU, Veradel® PESU and Acudel® mod. PPSU resins offer a superior combination of high-performance properties that include:

- Excellent thermal stability
- Outstanding toughness
- Good environmental stress cracking resistance
- High heat deflection temperature – over 213 °C (415 °F)
- Combustion resistance without additives
- Transparency
- Approved for food contact and poTable water use

Product-specific performance features include:

- Radel® PPSU demonstrates outstanding impact strength, having a notched Izod of 690 J/m (13 ft-lbs/inch). It can be disinfected and steam sterilized for over 1000 cycles without significant property loss, and it exhibits excellent resistance to prolonged exposure to hot chlorinated water
- Veradel® PESU combines good chemical resistance with inherent flame resistance and a UL Relative Thermal Index of 190 °C (374 °F), making it a good fit for electronic components and testing devices. Its high thermal properties also make it suiTable for baby bottles and other food service applications
- Acudel® mod. PPSU resins offer proprietary formulations that fill the cost-performance gap between PPSU and PSU

These properties – combined with easy processing – make the materials attractive for a wide variety of applications.

Examples of Radel® PPSU applications include sterilizable cases and trays for healthcare, dental instruments, medical device components, aircraft interiors and food service equipment.

Some examples of Veradel® PESU applications include cookware, water purification membranes, and adhesion promoters for coatings and composites.

Radel® PPSU and Acudel® modified PPSU are used in pipe fittings and manifolds for plastic piping systems.

Chemistry

Radel® PPSU and Veradel® PESU offer many of the excellent properties typical of Udel® PSU. Compared to Udel® PSU, Radel® PPSU has improved thermal capability, inherent flame resistance, better chemical resistance, and improved mechanical properties, including exceptional resistance to impact. Veradel® PESU offers improved thermal performance, comparable to that of Radel® PPSU, and chemical resistance between that offered by Udel® PSU and Radel® PPSU resins.

The chemical structures of Udel® PSU, Radel® PPSU, and Veradel® PESU are shown in Figure 1.

Figure 1: Chemical structures

Udel® PSU

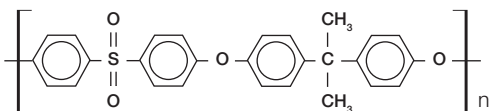

Radel® PPSU

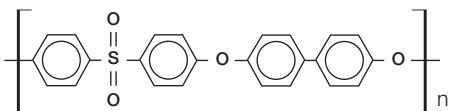

Veradel® PESU

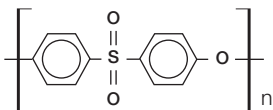

Chemistry and Related Properties

The stereo chemistry of the sulfone group disrupts any tendency for these polymers to melt crystallize, hence they are amorphous and exhibit high clarity and transparency.

These polymers are comprised of aromatic units (phenylenes) bridged with sulfone, ether, and in the case of Udel® PSU, isopropylidene moieties.

These “bridging” moieties, shown in Figure 2, impart special performance characteristics to polysulfones: hydrolytic stability, thermo-oxidative and melt stability, high use-temperatures and ductility. The electronegative sulfone group, in which sulfur is at its highest oxidation state, specifically affords excellent thermo-oxidative stability to the polymer, and simultaneously elevates the long-term use temperature.

Figure 2: Bridging moieties

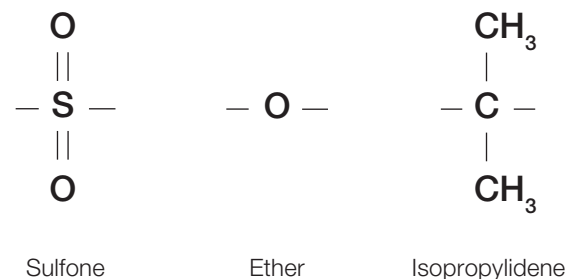

The phenylene ether segment contributes flexibility to the polymer backbone, which is manifested as high toughness, elongation, and ductility, as well as ease of melt fabrication. The outstanding hydrolytic stability that differentiates polysulfones from other engineering thermoplastics is a consequence of the resistance to aqueous hydrolysis of both the phenylene sulfone and ether groups. In contrast, competitive products, such as polycarbonates, polyesters, polyarylates, and polyetherimides, all contain bridging groups in their repeating units that are hydrolyzable, and therefore can exhibit molecular weight degradation resulting in severe property loss when exposed to aggressive aqueous environments, such as boiling water, steam, and caustic or acidic solutions.

Veradel® PESU possesses the highest concentration of sulfone moieties in the polymer’s repeating unit. This polar moiety attracts water, with the result that PESU has the highest water absorption of commercial sulfone polymers.

Radel® PPSU resin has a biphenylene unit that uniquely elevates the impact strength and reduces the notch sensitivity, resulting in notched Izod values greater than 690 J/m (13 ft·lb/in.).

Material Selection

The sulfone polymer family, which includes Radel® PPSU, Veradel® PESU and Udel® PSU, are amorphous resins that combine excellent thermal stability, high strength and toughness, excellent hydrolytic stability, transparency, and good resistance to environmental stress cracking. Acudel® mod. PPSU offers additional cost and performance advantages.

This section will highlight the differences between these sulfone polymers to help you decide which material will best meet your requirements.

As the lowest cost member of the family, Udel® PSU is the most widely used. It offers the lowest color and highest clarity, and its hydrolytic stability is exceeded only by the much higher performing Radel® PPSU. More information about Udel® PSU can be found in the *Udel® PSU Design Guide*, which can be obtained from your Solvay representative or from our website.

Figure 3 compares the relative thermal capability of Radel® PPSU, Veradel® PESU and Acudel® mod. PPSU resins to Udel® PSU and polycarbonate, and shows that the Radel® PPSU and Veradel® PESU resins are preferred for higher temperature environments.

Figure 3: Relative thermal capability of sulfone polymers

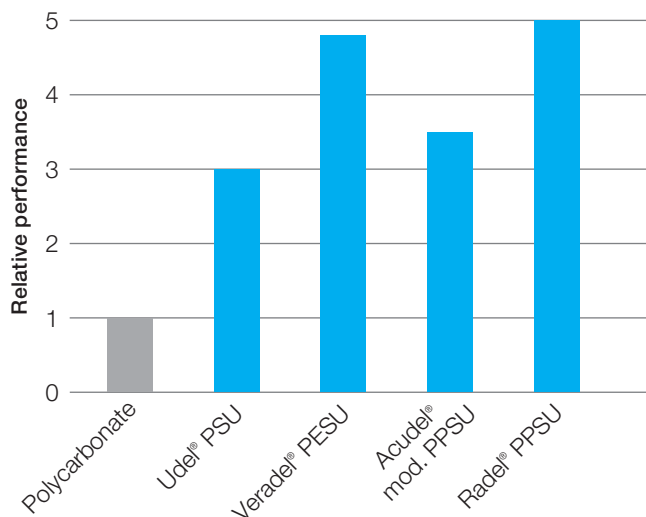
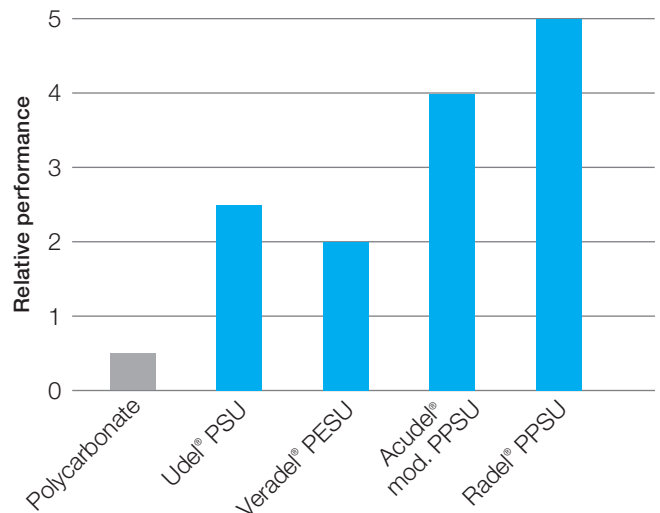

Figure 4 shows a comparison of the hydrolytic stability of these resins with polycarbonate and PSU. The hydrolytic stability of Udel® PSU is excellent and surpassed only by Radel® PPSU and Acudel® mod. PPSU.

Figure 4: Hydrolytic stability of sulfone polymers



The relative performance of the Radel® PPSU and Veradel® PESU resins when exposed to organic solvents is shown in Figure 5. The graph shows that Radel® PPSU has by far the greatest resistance to attack and/or stress cracking from organic solvents. Veradel® PESU, Acudel® mod. PPSU, and Udel® PSU are clearly better than polycarbonate.

Figure 5: Chemical resistance of sulfone polymers

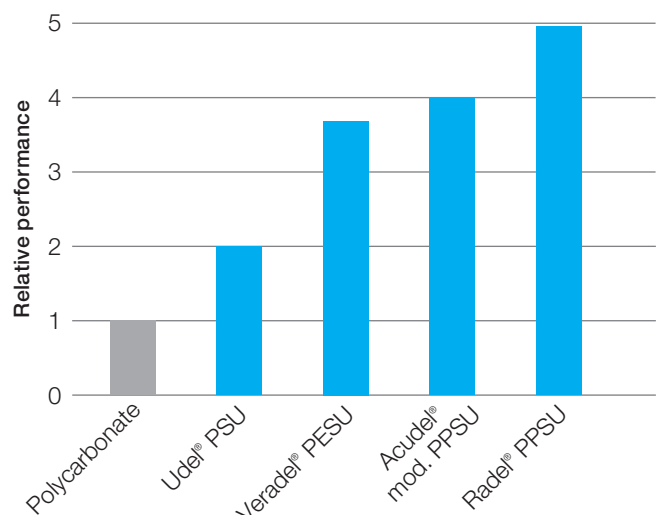

A key property in many applications is impact resistance, which is a difficult property to quantify. Some tests measure notch sensitivity and others measure resistance to high-speed penetration. Figure 6 shows an estimate of the practical impact resistance of Radel® PPSU resin which includes drop impact ratings as well as tensile impact results. The Figure shows that these resins are tough, ductile materials and they all have excellent practical impact resistance.

Figure 6: Impact resistance of sulfone polymers

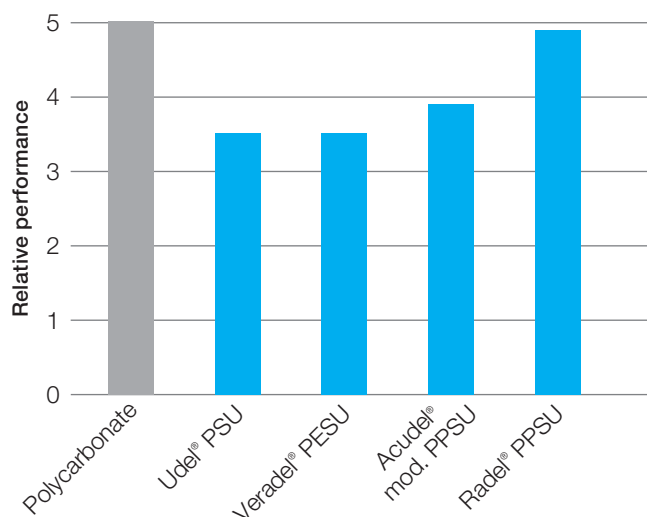

Veradel® PESU is available in both unfilled grades and glass-reinforced grades. Both types are available in a range of melt viscosities.

Veradel® PESU is indicated when a sulfone polymer with higher thermal capability, inherent flame resistance, better chemical resistance, and improved mechanical properties than polysulfone are required.

The glass-reinforced grades offer higher stiffness and dimensional stability, with attendant benefits in creep resistance, chemical resistance, and lower thermal expansion. Veradel® AG-320 and AG-330 resins are especially cost-effective, glass-reinforced grades containing 20% and 30% glass fiber respectively.

Radel® PPSU is the material of choice for the ultimate in toughness with chemical and hydrolysis resistance superior to all commercially available transparent resins or when resistance to commercial autoclave environments is needed.

Radel® PPSU is offered in several grades: R-5000, the general purpose transparent grade; R-5100 colors; R-5500 for extrusion; R-5800 and R-5900, higher flow transparent grades for injection molding; and RG-5030 30% glass fiber reinforced.

Acudel® mod. PPSU resin is unfilled, opaque modified polyphenylsulfone designed to satisfy a broad range of challenging application design and end-use requirements.

Both Radel® PPSU and Veradel® PESU can be color matched to a wide range of colors, both transparent and opaque.

Nomenclature

For Veradel® PESU resins, the first digit of the grade number is used to indicate the relative melt viscosity. The mechanical, physical, thermal, and chemical resistance properties of neat and glass-filled Veradel® PESU resins have been shown to be equivalent for all melt viscosities, except where noted.

Table 1 shows the grade designations of the unfilled sulfone grades and the relative melt viscosities, as measured by ASTM D1238 expressed as melt flow rate.

Table 1: Melt flow rates of neat grades

Grade	Typical Melt Flow Rate [g/10 min]
Radel® PPSU resins at 365°C (689°F), 5.0 kg	
R-5500*	11
R-5000/5100	17
R-5800	25
Acudel® mod. PPSU resins at 380°C (716°F), 2.16 kg	
22000	12
Veradel® PESU resins at 380°C (716°F), 2.16 kg	
A-201	20
A-301	30

* Extrusion grade

The glass-reinforced grades are indicated by adding a “G” to the basic family descriptor. Table 2 shows the composition and melt flows of the glass-reinforced Radel® PPSU and Veradel® PESU resins.

Table 2: Melt flow rates of glass-reinforced grades

Grade	Composition	Melt Flow Rate [g/10 min]
Radel® PPSU resins at 365°C (689°F), 5.0 kg		
RG-5030	30% Glass fiber	15
Veradel® PESU resins at 380°C (716°F), 2.16 kg		
AG-320	20% Glass fiber	14
AG-330	30% Glass fiber	12

Approvals

Radel® PPSU and Veradel® PESU resins comply with the requirements of several governmental and/or regulatory agencies, as shown below. As regulatory action is an ongoing activity, please contact your Solvay representative for information regarding a specific application requiring agency approval or recognition.

Food Contact

United States Food and Drug Administration (FDA)

Veradel® PESU complies with regulation 21 CFR 177.2440, and is therefore permitted by FDA for use as articles or components of articles intended for repeated use in contact with food. Radel® PPSU complies with the Food Contact Notification Number 000083, and is suitable to be used in repeat use food contact applications with all food types, under FDA conditions B through H.

European Commission Directive 2002/72/EEC

Commission Directive Relating to Plastic Materials and Articles Intended to Come in Contact with Foodstuffs. Several grades of Radel® PPSU, Acudel® mod. PPSU and Veradel® PESU are recognized under each of these standards. Information on current listings for specific grades is available from your Solvay representative.

ISO 10993

We have several grades of sulfone polymers that comply with the requirements of ISO 10993 and are therefore suitable for use in Class II and Class III medical devices. Please consult with your sales representative for further details.

Only Solvay products designated as being part of the Solviva®⁽¹⁾ family of biomaterials may be considered candidates for medical applications implanted in the human body and devices that are in contact with bodily fluids or tissues for greater than 24 hours.

National Sanitation Foundation

NSF International is a not-for-profit, non-governmental organization that develops standards for public health and safety. It also provides lists of materials that conform to their standards. For more complete information about NSF, please visit their website at www.nsf.org. Of their many standards, two are especially important for sulfone polymers: standard 51 “Food Equipment Materials” and standard 61 “Potable Water Materials.”

⁽¹⁾ Solviva® is a registered trademark of the Solvay Group.

NSF standard 51: Food equipment materials

Table 3 lists the sulfone polymers certified to this standard and the maximum use temperature for the certification. The standard lists these food types: dry solids, aqueous, acidic, dairy products, oil, and alcoholic beverages. The listed materials are certified for all food types.

Table 3: NSF standard 51 certified materials

Grade	Maximum Use Temperature [°C (°F)]
Radel® PPSU	
R-5000	191 (375)
R-5100 NT15	191 (375)
R-5900 NT	191 (375)
Acudel® mod. PPSU	
22000 BK937	100 (212)
22000 NT15	100 (212)
Veradel® PESU	
AG-320 NT	191 (375)
AG-330 NT	191 (375)

NSF standard 61: Drinking water system components – health effects

Table 4 lists the sulfone polymers certified to meet NSF standard 61 at 82 °C (180 °F).

Table 4: NSF standard 61 certified materials

Radel® PPSU		
R-5000 NT	R-5100 BK937LF	R-5100 BK937
R-5100 BU1197	R-5100 GY1037	R-5100 GY1037LF
R-5100 NT15		
Acudel® mod. PPSU		
22000 BK937	22000 WH6417	22000 NT15
Veradel® PESU		
3000P	3100	3200P
3300	3330NT	3400
3500		

These tables are provided for your information only. Prior to use in an application requiring certification, you are strongly urged to go to www.NSF.org/business/search_listings to get the latest listing.

International Water Contact Standards

Listings expire periodically and depending on market demand they may or may not be recertified. Contact your Solvay representative for the latest listing.

French ACS Sanitary Conformity Certificate

Table 5 lists the Radel® PPSU and Veradel® PESU grades that have received the French Attestation de Conformité Sanitaire “ACS” (Sanitary Conformity Certificate) for materials and accessories.

Table 5: Radel® PPSU and Veradel® PESU resins complying with French ACS

Radel® R-5100 BK937

Radel® R-5100 BU1197

Radel® R-5100 NT15

Veradel® 3330GF

Veradel® AG-330 NT

Water byelaws scheme – United Kingdom

Table 6 lists the Radel® PPSU and Veradel® PESU grades that have passed the tests of effect on water quality – BS 6920, and are suitable for use in contact with potable water and will be included in the Materials section, Part Two of the Water Fittings and Materials Directory. These products are also approved for cold water and hot water use up to 85 °C (185 °F).

Table 6: Radel® PPSU resins listed as complying with BS 6920

Radel® R-5000 NT

Radel® R-5100 NT15

Radel® R-5100 BK937

Radel® R-5100 GY1037

Radel® R-5100 BU1197

German Federal Health Office

Table 7 lists the resins that have been tested and found to be in accordance with the KTW recommendations of the German Federal Health Office at temperatures up to 90 °C (194 °F).

Table 7: Sulfone grades listed by KTW

Veradel® AG-330 NT

Radel® R-5100 GY1037

Radel® R-5000 NT

Radel® R-5100 NT15

Radel® R-5100 BK937

Acudel® 22000 GY1037

Radel® R-5100 BU1197

Acudel® 22000 BK937

Underwriters Laboratories

Many commercial grades of Radel® PPSU, Acudel® mod. PPSU, and Veradel® PESU are listed in Underwriters Laboratories' Recognized Component Directory. Data relating to short-term performance are given in Table 24 on page 27. Long-term performance ratings are shown in Table 22 on page 25. For the most current listing information, visit the Underwriters Laboratories, Inc., website at www.ul.com.

The mechanical properties of a material are of fundamental importance in component design. The designer must match the requirements of the application to the mechanical properties of the material to achieve an optimal part design.

With polymeric materials, the mechanical properties are more time and temperature dependent than those of metals, and in some ways, they are more affected by environmental factors. To design successfully with polymeric materials, the designer must consider not only the short-term mechanical properties, but also the time, temperature, and environmental demands of each application.

Short-Term Properties

The mechanical properties typically listed in a material supplier's data sheet are short-term properties. In some cases, these values may be considered an indication of the absolute maximum capability of a material.

Typically, these property values are obtained by preparing a special test specimen, then subjecting it to an increasing load until failure, usually rupture, occurs. The test specimens are designed for obtaining reproducible results, and may give higher values than would be obtained if specimens machined from an actual part were tested. Because the tests are run quickly, the time-related effects are minimized.

Environmental factors are eliminated by running the tests in a controlled environment, thereby avoiding any reduction in properties from chemical exposure. Short-term mechanical properties usually include tensile strength and modulus, flexural strength and modulus, notched Izod impact, compressive strength, shear strength, and surface hardness.

Typical Properties Tables

The typical properties of Radel® PPSU, Veradel® PESU and Acudel® mod. PPSU resins are shown in Tables 8 and 9 on page 10 and 11.

Tensile Properties

Tensile properties are determined by clamping a test specimen into the jaws of a testing machine and separating the jaws at a specified rate in accordance with ASTM D638. The force required to separate the jaws divided by the minimum cross-sectional area is defined as the tensile stress. The test specimen will elongate as a result of the stress, and the amount of elongation divided by the original length is the strain.

If the applied stress is plotted against the resulting strain, a curve similar to that shown in Figure 7 is obtained for ductile polymers like polysulfones.

Figure 7: Typical stress-strain curve

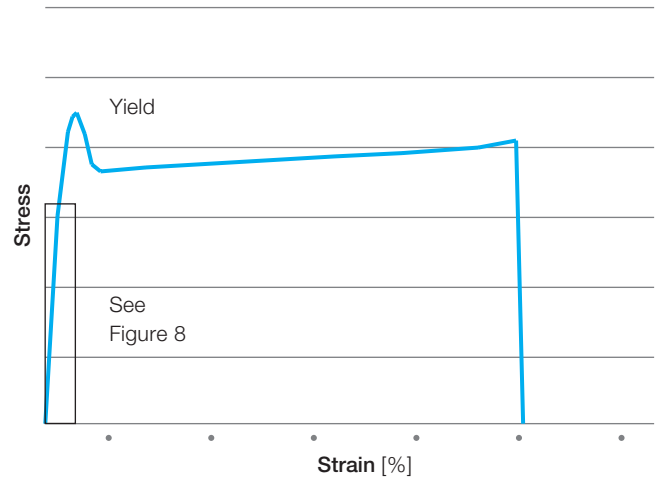

The initial portion of the stress-strain curves is of special interest, and is shown in Figure 8. This Figure shows that strain is directly proportional to stress, up to a certain level of stress. This region is known as the “Hookean” region, and the limiting stress is known as the proportional limit. The tensile modulus is the slope of the stress/strain curve when a specimen is subjected to a tensile loading. Measuring the slope of a curved line is difficult, and some conventions have been developed to standardize the testing and reduce the variability in test results.

Figure 8: Stress-strain curve insert (Figure 7), secant vs. tangent modulus

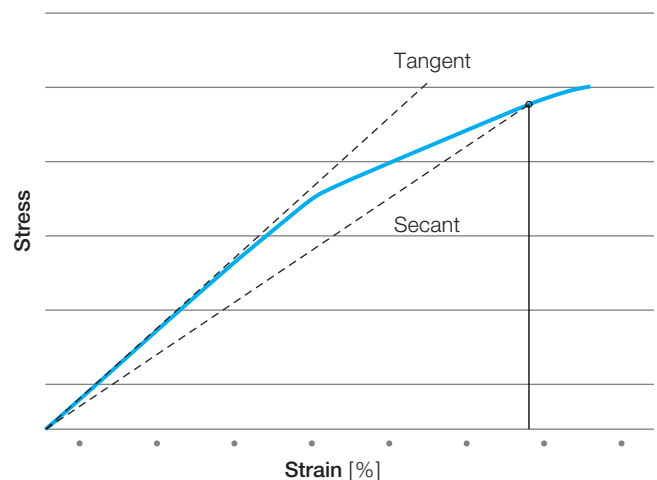

Table 8: Typical properties⁽¹⁾ – SI Units

Property	Unit	Radel®		Veradel®			Acudel®	ASTM Test Method
		R-5800 R-5500 R-5100 R-5000	RG-5030	A-301A A-201A	AG-320	AG-330	22000	
Mechanical								
Tensile strength	MPa	70	120	83	105	126	77	D638
Tensile modulus	GPa	2.34	9.17	2.65	5.70	8.62	2.69	D638
Tensile elongation								
at yield	%	7.2		6.5	3.2	1.9	6.7	D638
at break	%	60–120	2.4	25–75	3.2	1.9	25–75	D638
Flexural strength	MPa	105	173	111	145	179	108	D790
Flexural modulus	GPa	2.41	8.07	2.90	5.17	8.07	2.76	D790
Compressive strength	MPa	99		100	151	177		D695
Compressive modulus	GPa			2.68	6.03	7.72		D695
Shear strength	MPa	61		55	61	65	58	D732
Izod impact strength								
notched	J/m	694	75	53	59	75	106	D256
unnotched	J/m	NB ⁽²⁾	640	NB	640	530	NB	D256
Tensile impact	kJ/m ²	400		336	65	71		D1822
Rockwell hardness		R122		R127		R121		D785
Thermal								
Heat deflection temperature ⁽³⁾								
at 0.45 MPa	°C	214		214	218	220		D648
at 1.82 MPa	°C	207	210	204	214	216	197	D648
Vicat softening point	°C			214	217	218		D1525B
Thermal expansion coefficient	µm/m·°C	56	18	49	31	31	63	E831
Thermal conductivity	W/m·K	0.30		0.24		0.30	0.24	E1530
Glass transition temperature	°C	220	220	220	220	220	220 ⁽⁵⁾	DSC
Combustion⁽⁴⁾								
Oxygen index	%	38		39	40	40	38	D2863
UL-94 rating at 0.8 mm		V-0		V-0	V-0	V-0		UL-94
Self-ignition temperature	°C			502				D1929
Electrical								
Dielectric strength	kV/mm	15	16	15	17	17	18	D149
Volume resistivity	ohm·cm	>10 ¹⁵	>9·10 ¹⁵	1.7·10 ¹⁵	>10 ¹⁶	>10 ¹⁶	>9·10 ¹⁵	D257
Dielectric constant								
at 60 Hz		3.44		3.51	3.84	4.11		D150
at 10 ³ Hz		3.45		3.50	3.84	4.13		D150
at 10 ⁶ Hz		3.45	3.90	3.54	3.88	4.17	3.40	D150
Dissipation factor								
at 60 Hz		0.0006		0.0017	0.0015	0.0019		D150
at 10 ³ Hz				0.0022	0.0018	0.0018		D150
at 10 ⁶ Hz		0.0076	0.0090	0.0056	0.0081	0.0094	0.0080	D150
Physical								
Specific gravity		1.29	1.53	1.37	1.51	1.58	1.28	D792
Refractive index		1.672		1.651				
Water absorption ⁽⁶⁾ at 24 hr	%	0.4	0.3	0.5	0.4	0.4	0.3	D570
Water absorption ⁽⁶⁾ at 30 days	%	1.1	0.7	1.8			0.8	D570

⁽¹⁾ Typical Values – Actual properties of individual batches will vary within specification limits

⁽²⁾ NB = no break

⁽³⁾ Annealed 3.2 mm bar

⁽⁴⁾ The data regarding combustion and combustibility are the results of small-scale laboratory tests and do not reflect the hazards of these or any other material under actual fire conditions

⁽⁵⁾ Value shown is value of major component

⁽⁶⁾ Measured from completely dry

Table 9: Typical properties⁽¹⁾ – US Customary Units

Property	Unit	Radel®		Veradel®			Acudel®	ASTM Test Method
		R-5800 R-5500 R-5100 R-5000	RG-5030	A-301A A-201A	AG-320	AG-330	22000	
Mechanical								
Tensile strength	kpsi	10.1	17.4	12.0	15.2	18.3	11.2	D638
Tensile modulus	kpsi	340	1,330	385	825	1,250	390	D638
Tensile elongation								
at yield	%	7.2		6.5	3.2	1.9	6.7	D638
at break	%	60–120	2.4	25–75	3.2	1.9	25–75	D638
Flexural Strength	kpsi	15.2	25.1	16.1	21.0	26.0	15.7	D790
Flexural modulus	kpsi	350	1,170	420	750	1,170	400	D790
Compressive strength	kpsi	14.4		14.5	21.9	25.6		D695
Compressive modulus	kpsi			388	875	1,120		D695
Shear strength	kpsi	8.8		8.0	8.8	9.5	8.4	D732
Izod impact strength								
notched	ft·lb/in	13.0	1.4	1.0	1.1	1.4	2.0	D256
unnotched	ft·lb/in	NB	12	NB	12	10	NB	D256
Tensile impact	ft·lb/in ²	190		160	31	34	175	D1822
Rockwell hardness		R122		R127		R121		D785
Thermal								
Heat deflection temperature ⁽³⁾								
at 66 psi	°F	417		417	424	428		D648
at 264 psi	°F	405	410	399	417	420	387	D648
Vicat softening point	°F			418	422	424		D1525B
Thermal expansion coefficient	µin/in°F	31	10	27	17	17	35	E831
Thermal conductivity	⁽⁵⁾	2.08		1.66		2.08	1.66	E1530
Glass transition temperature	°F	428	428	428	428	428	428 ⁽⁶⁾	DSC
Combustion⁽⁴⁾								
Oxygen index	%	38		39	40	40	38	D2863
UL-94 rating at 0.031 inch		V-0		V-0	V-0	V-0		UL-94
Self-ignition temperature	°F			936				D1929
Electrical								
Dielectric strength	volts/mil	360	400	380	440	440	470	D149
Volume resistivity	ohm·cm	>10 ¹⁵	>9·10 ¹⁵	1.7·10 ¹⁵	>10 ¹⁶	>10 ¹⁶	>9·10 ¹⁵	D257
Dielectric constant								
at 60 Hz		3.44		3.51	3.84	4.11		D150
at 10 ³ Hz		3.45		3.50	3.84	4.13		D150
at 10 ⁶ Hz		3.45	3.90	3.54	3.88	4.17	3.40	D150
Dissipation factor								
at 60 Hz		0.0006		0.0017	0.0015	0.0019		D150
at 10 ³ Hz				0.0022	0.0018	0.0018		D150
at 10 ⁶ Hz		0.0076	0.0090	0.0056	0.0081	0.0094	0.0080	D150
Physical								
Specific gravity		1.29	1.53	1.37	1.51	1.58	1.28	D792
Refractive index		1.672		1.651				
Water absorption ⁽⁷⁾ at 24 hr	%	0.4	0.3	0.5	0.4	0.4	0.3	D570
Water absorption ⁽⁷⁾ at 30 days	%	1.1	0.7	1.8			0.8	D570

⁽¹⁾ Typical Values – Actual properties of individual batches will vary within specification limits

⁽²⁾ NB = no break

⁽³⁾ Annealed 0.125 inch bar

⁽⁴⁾ The data regarding combustion and combustibility are the results of small-scale laboratory tests and do not reflect the hazards of these or any other material under actual fire conditions.

⁽⁵⁾ Units are $\frac{\text{BTU} \cdot \text{in}}{\text{hr} \cdot \text{ft}^2 \cdot ^\circ\text{F}}$

⁽⁶⁾ Value shown is value of major component

⁽⁷⁾ Measured from completely dry

One method uses the slope of a line drawn tangent to the curve, and another method utilizes the slope of a secant drawn through the origin and some arbitrarily designated strain level. The tangent method was used for these data.

Ductile polymers undergo “yield” prior to rupture. At the onset of jaw separation, the stress or force required to elongate the specimen is directly proportional to the elongation or strain. As the test proceeds, the specimens exhibit greater amounts of permanent deformation until the point where additional elongation is achieved with the application of less than the proportional amount of stress. This point is called “yield” and the stress level is often referred to as tensile strength at yield. The elongation is called elongation at yield or yield strain. As the test proceeds, the specimen is elongated until rupture occurs. The stress level at this point is called tensile strength at break or ultimate tensile strength. The test method used for determining tensile properties, ASTM D638, defines tensile strength as the greater of the stress at yield or the stress at rupture.

Stress-Strain Curves

Typically, tensile property data are presented by tabulating specific data, such as tensile strength, tensile modulus, and elongation. While these data are generally adequate for most purposes, the actual stress-strain curve provides additional information about a material’s response to load that design engineers may find useful when they estimate the viability of a part design.

Figures 9 through 13 present the stress-strain curves for several Radel® PPSU, Veradel® PESU and Acudel® mod. PPSU resins. The test on unfilled resins was terminated at yield, while the tests on glass-reinforced resins were run until rupture.

Figure 9: Veradel® A-301 stress-strain curve to yield

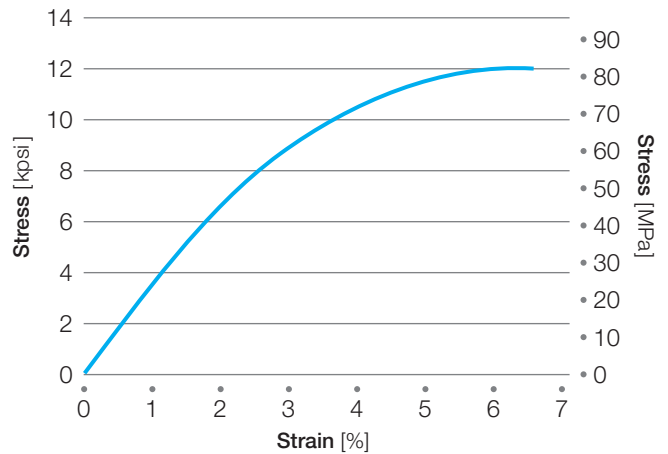

Figure 10: Radel® R-5000 stress-strain curve to yield

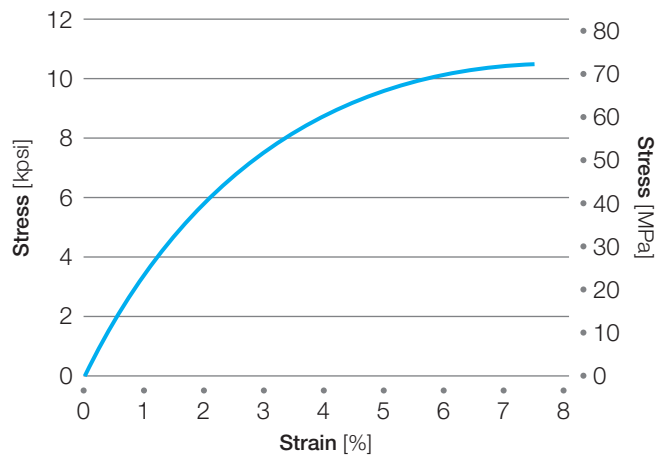

Figure 11: Acudel® 22000 stress-strain curve to yield

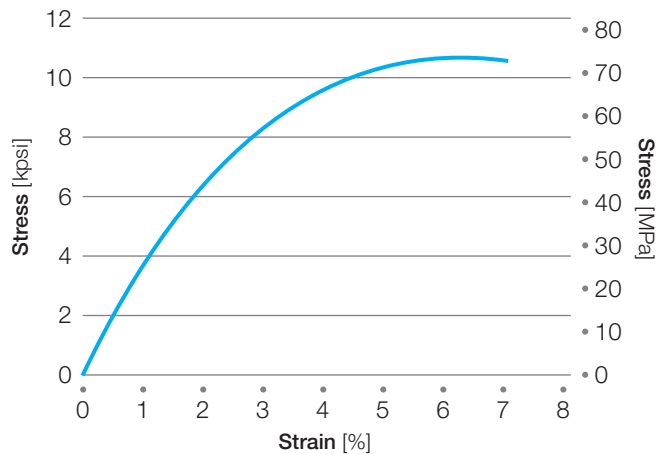

Figure 12: Veradel® AG-320 stress-strain curve to break

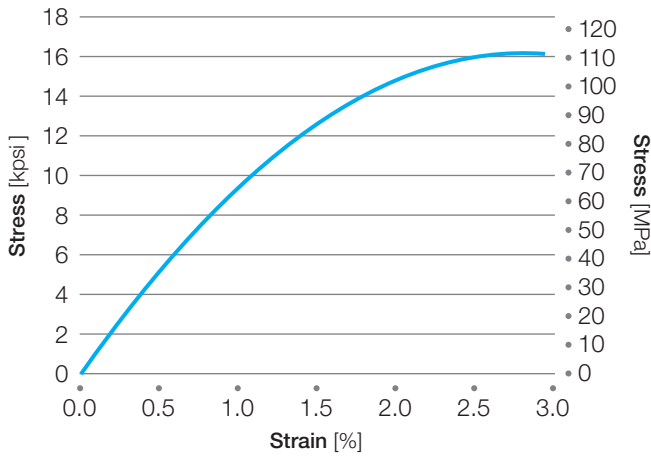

Figure 13: Veradel® AG-330 stress-strain curve to break

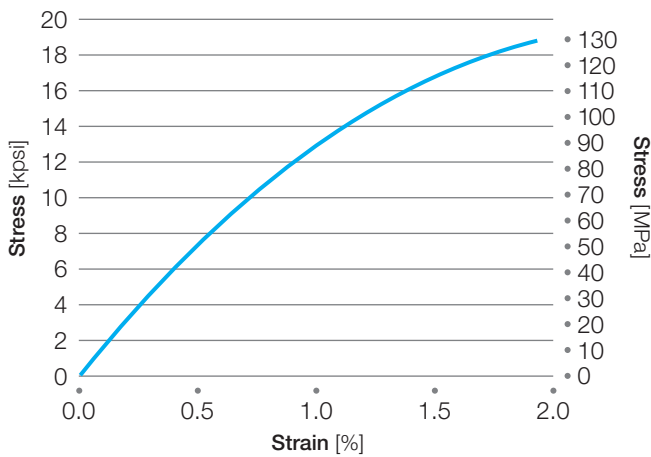

Table 10 shows that Veradel® PESU has a tensile strength about 20% higher than either Udel® PSU or Radel® PPSU. Radel® PPSU has greater elongation at both yield and break and a lower modulus, indicating greater ductility. This higher ductility results in greater toughness and lower sensitivity to stress concentrations.

Table 10: Tensile properties of neat resins (ASTM D638)

Material	Strength	Modulus	Elongation	Elongation
	[MPa (kpsi)]	[GPa (kpsi)]	at Yield [%]	at Break [%]
Radel® PPSU	70 (10.1)	2.34 (340)	7.2	60–120
Veradel® PESU	83 (12.0)	2.65 (385)	6.5	25–75
Acudel® mod. PPSU	77 (11.2)	2.69 (390)	6.7	25–75
Udel® PSU	70 (10.2)	2.48 (360)	5–6	50–100

Figure 14 shows the room temperature tensile strength of glass-reinforced Veradel® PESU. As expected, adding glass fiber reinforcement causes the tensile strength to increase.

Figure 14: Tensile strength of glass-filled Veradel® PESU

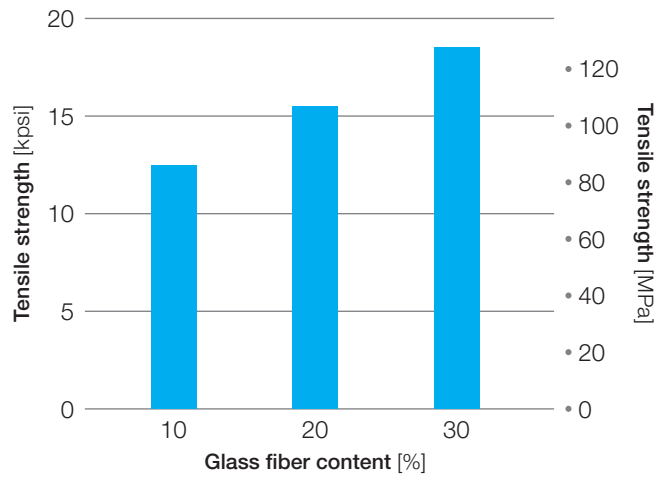

As shown in Figure 15, the tensile modulus of Veradel® PESU increases with glass content.

Figure 15: Tensile modulus of glass-filled Veradel® PESU

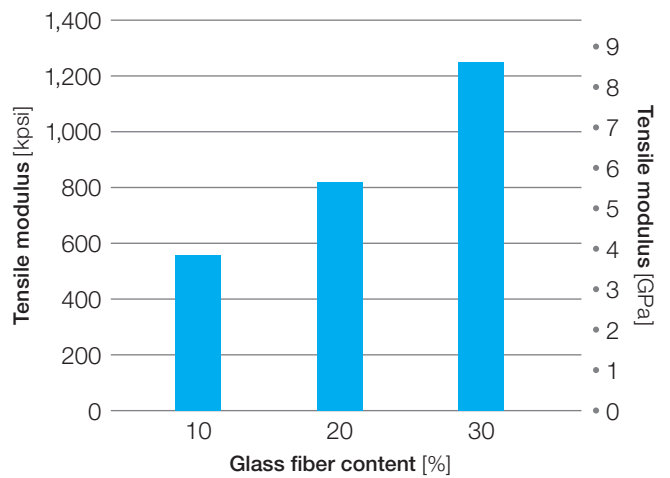

Flexural Properties

The flexural properties were determined in accordance with ASTM D790 Method I using the three-point loading method shown in Figure 16. In this method, the 127 × 13 × 3.2 mm (5.0 × 0.5 × 0.125 in.) test specimen is supported on two points, while the load is applied to the center. The specimen is deflected until rupture occurs or the fiber strain reaches five percent.

Figure 16: Flexural test apparatus

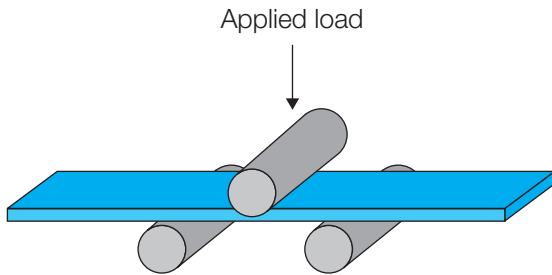

Flexural testing provides information about a material's behavior in bending. In this test, the bar is simultaneously subjected to tension and compression.

As shown in Table 11, Veradel® PESU resin has the greatest flexural strength and modulus. The flexibility of Radel® PPSU resin is indicated by the lower flexural modulus.

Table 11: Flexural properties of neat resins

Material	Strength [MPa (kpsi)]	Modulus [GPa (kpsi)]
Radel® PPSU	105 (15.2)	2.41 (350)
Acudel® mod. PPSU	108 (15.7)	2.76 (400)
Veradel® PESU	111 (16.1)	2.90 (420)
Udel® PSU	106 (15.4)	2.69 (390)

Adding glass fibers improves the flexural strength of Veradel® PESU resins, as shown in Figure 17.

Figure 17: Flexural strength of glass-filled Veradel® PESU

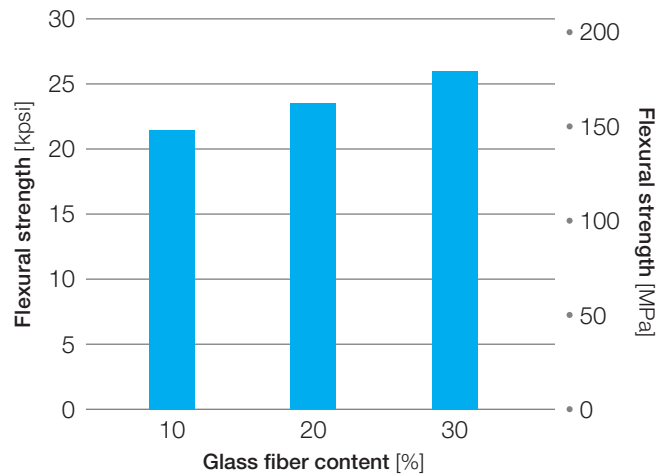
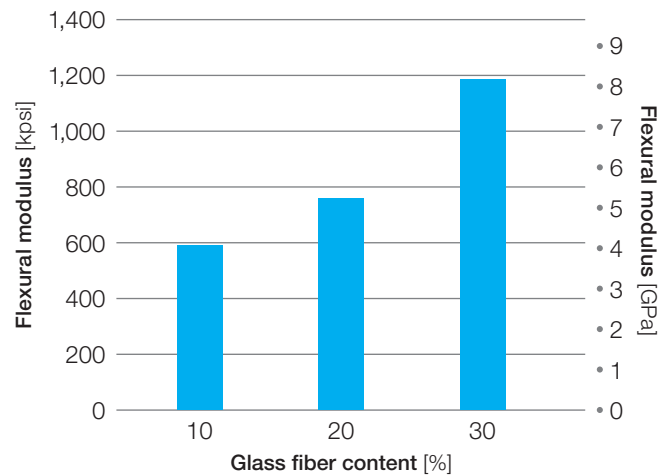

Figure 18 shows that the glass-filled grades have much higher moduli than the neat materials, suggesting that glass-filled materials should be used in applications requiring higher stiffness and/or lower creep.

Figure 18: Flexural modulus of glass-filled Veradel® PESU



Compressive Properties

Compressive strength and modulus were measured in accordance with ASTM D695. In this test, the test specimen is placed between parallel plates. The distance between the plates is reduced while the load required to push the plates together and the plate-to-plate distance is monitored. The maximum stress endured by the specimen (this will usually be the load at rupture) is the compressive strength, and the slope of the stress/strain curve is the compressive modulus.

The compressive strengths of Radel® PPSU, Veradel® PESU and Udel® PSU, as shown in Table 12, are similar. The compressive modulus of Veradel® PESU is very close to that of Udel® PSU. Glass fiber substantially increases the compressive strength as shown in Figure 19. The compressive modulus is similarly increased, as seen in Figure 20.

Table 12: Compressive properties of neat resins

Property	Udel® PSU [MPa (kpsi)]	Veradel® PESU [MPa (kpsi)]	Radel® PPSU [MPa (kpsi)]
Strength	96 (13.9)	100 (14.5)	99 (14.3)
Modulus	2.6 (374)	2.7 (388)	–

Figure 19: Compressive strength of glass-filled Veradel® PESU

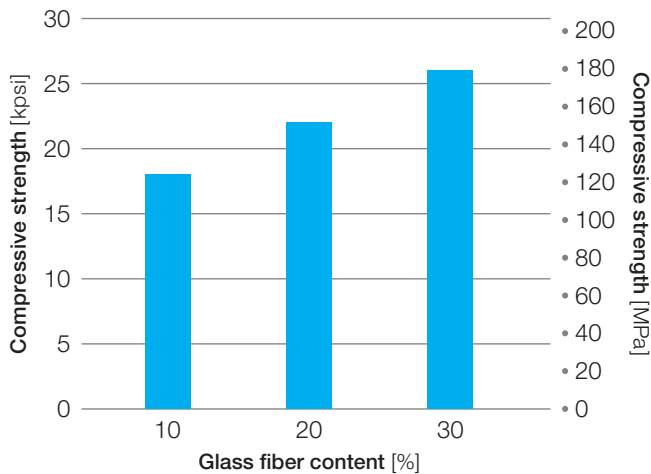
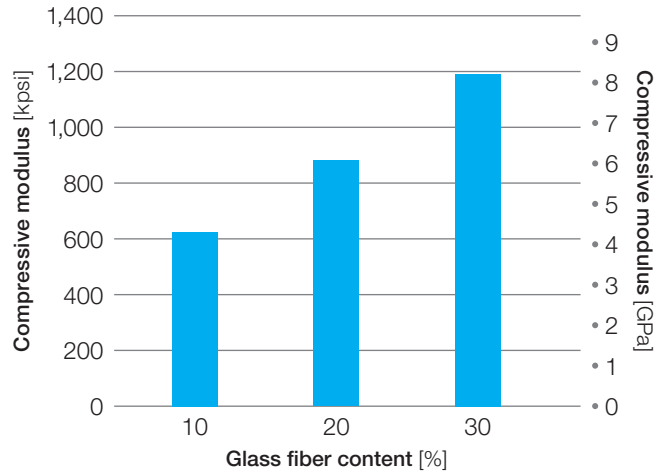

Figure 20: Compressive modulus of glass-filled Veradel® PESU



Shear Properties

Shear strength is determined in accordance with ASTM D732. In this test, a plaque is placed on a plate with a hole below the specimen. A punch with a diameter slightly smaller than the hole is pushed through the material, punching out a circular disc. The maximum stress is reported as the shear strength.

The shear strengths of the neat sulfone polymers are shown in Table 13. Adding glass fiber reinforcement yields higher shear strengths, as shown in Figure 21.

Table 13: Shear strength of neat resins

Material	Shear Strength [MPa (kpsi)]
Udel® PSU	62 (9.0)
Veradel® PESU	57 (8.3)
Radel® PPSU	61 (8.8)
Acudel® mod. PPSU	58 (8.4)

Figure 21: Shear strength of glass-filled Veradel® PESU

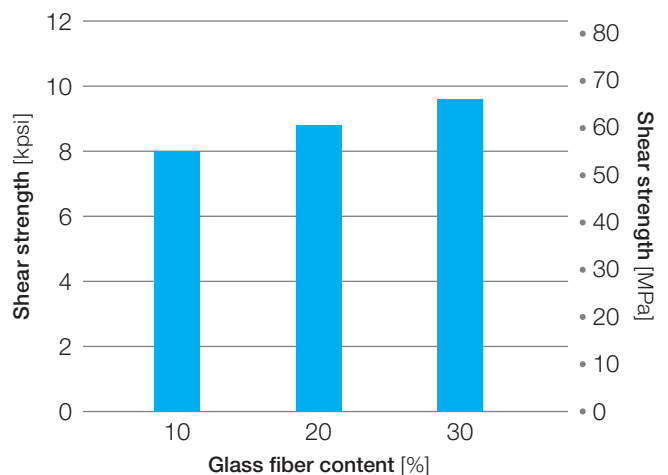

Impact Properties

Because polymers are visco-elastic, their properties depend upon the rate at which load is applied. When the loading rate is rapid, the part is said to be subjected to impact loading.

An example of a common impact loading is a drop test, in which the plastic part is dropped from a known height onto a hard, unyielding surface, such as a concrete floor. If a plastic part is to survive the collision without damage, it must be able to absorb the kinetic energy contained by the part prior to the collision. The ability of a plastic part to absorb energy is a function of its shape, size, thickness, and the type of plastic. The impact resistance testing methods currently in use do not provide the designer with information that can be used analytically. The tests are only useful for determining relative impact resistance, and comparing notch sensitivities of materials.

Notched Izod

The notched Izod test (ASTM D256) is one of the most widely employed methods for comparing polymeric materials. In this test, a test specimen is prepared by machining in a notch with a radius of 0.25 mm (0.010 in.), a depth of 2.5 mm (0.10 in.) and an angle of 45°. The notched specimen is then struck by a swinging pendulum, as illustrated in Figure 22. After the impact the pendulum continues to swing, but with less energy due to the collision. The amount of energy lost is reported as the Izod impact strength in units of foot-pounds per inch or Joules per meter of beam thickness.

Figure 22: Izod impact test apparatus

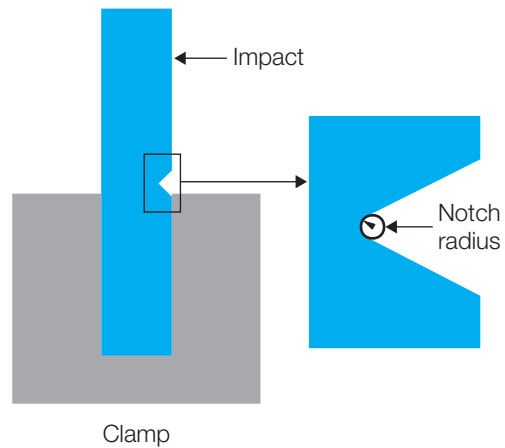

As shown in Figure 23, Radel® PPSU exhibits exceptional impact resistance by the notched Izod method. While Udel® PSU and Veradel® PESU are generally considered to have good impact resistance, the impact resistance of Radel® PPSU is an order of magnitude higher.

Figure 23: Notched Izod of neat resins

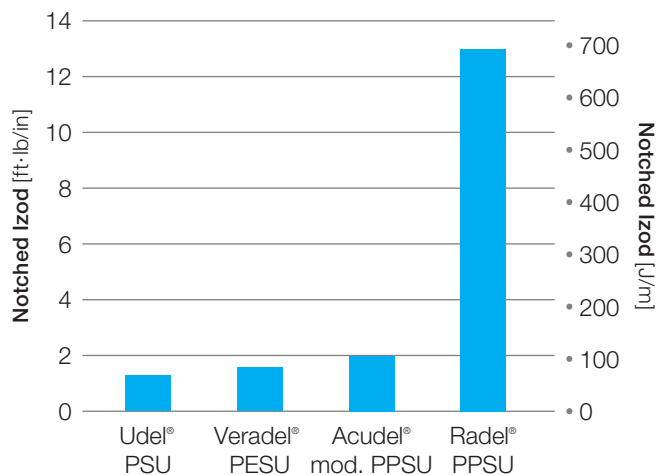

Failure of a material under impact conditions requires that a crack form, then propagate through the specimen. In the notched Izod test, the notch acts like a crack and the test is primarily measuring crack propagation resistance. When the test is run without a notch, a crack must first be formed, then propagate. Sulfone polymers are extremely resistant to crack formation, as evidenced by the fact that none of the neat resins break in the un-notched test.

Notch sensitivity

Another method of evaluating notch sensitivity is to measure notched Izod using varying notch radii. Materials that are very notch sensitive will show a strong negative response to sharper notches, i.e., smaller notch radii.

As shown in Figure 24, Radel® PPSU has very good resistance to property loss due to sharp notches. In fact, it is similar to polycarbonate in this respect. Veradel® PESU is sensitive to sharp notches but shows excellent toughness when the notch radius is greater than 0.5 mm (20 mils). Acudel® mod. PPSU resin has good toughness when the notch radius is 0.4 mm (15 mils) or larger.

Figure 24: Notched Izod impact as a function of notch radius

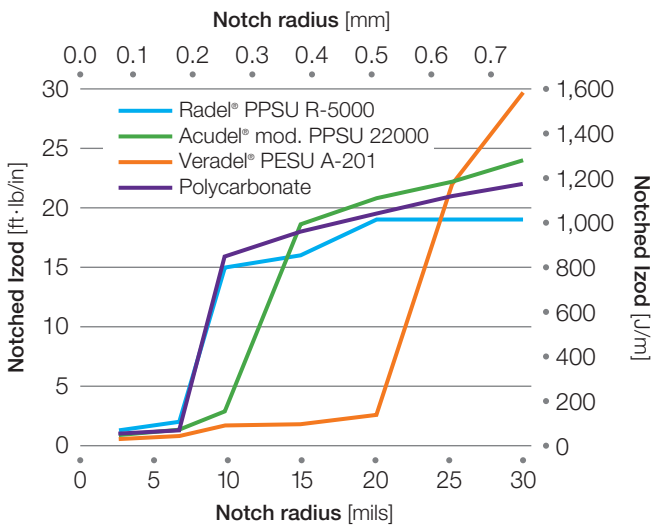

Tensile impact

Tensile impact is similar to the Izod impact test in that a pendulum is used, but the specimen is subjected to a high speed tensile loading rather than the flexural loading of the Izod test. Also, in this test the specimens are not notched. The method described in ASTM D1822 was followed. The results give a better indication of practical impact resistance than the Izod test.

Figure 25 shows that all three types of sulfone polymers are quite ductile according to this test. Acudel® mod. PPSU is also quite ductile.

Figure 25: Tensile impact strength of neat resins

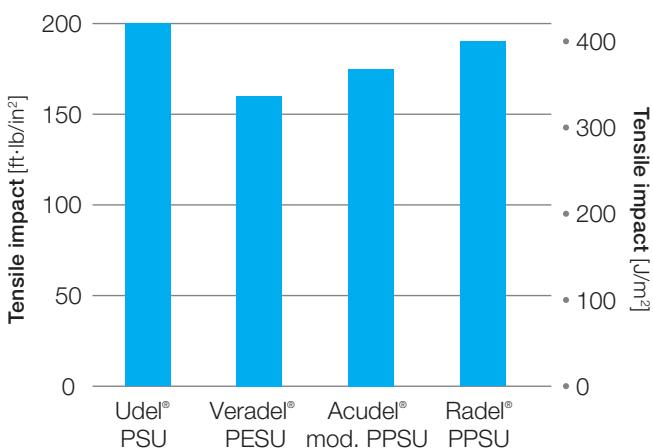

Poisson's Ratio

Poisson's ratio is the ratio of lateral strain to longitudinal strain within the proportional limit. To illustrate, consider a cylindrical bar subjected to tensile stress, the length (L) increases and simultaneously its diameter (D) decreases. Poisson's ratio (u) would be calculated by:

$$u = \frac{-\Delta D}{\frac{\Delta L}{L}}$$

The value of Poisson's ratio was measured according to ASTM E132. The results are shown in Table 14.

Table 14: Poisson's ratio

Material	Material Type	u
Radel® PPSU	Neat	0.43
Veradel® PESU	Neat	0.41
Udel® PSU	Neat	0.37
Veradel® AG-320/330	Glass-filled	0.42
Acudel® 22000	Glass-filled	0.41

Wear Resistance

To evaluate the relative resistance to abrasive wear, the Taber Abrasion Test was used with a CS-17 wheel and a 1,000 gram load. As shown in Figure 26, the abrasion resistance of Veradel® PESU resin is quite similar to that of Udel® PSU, and the inclusion of glass fiber reinforcement has little effect.

Figure 26: Abrasion resistance

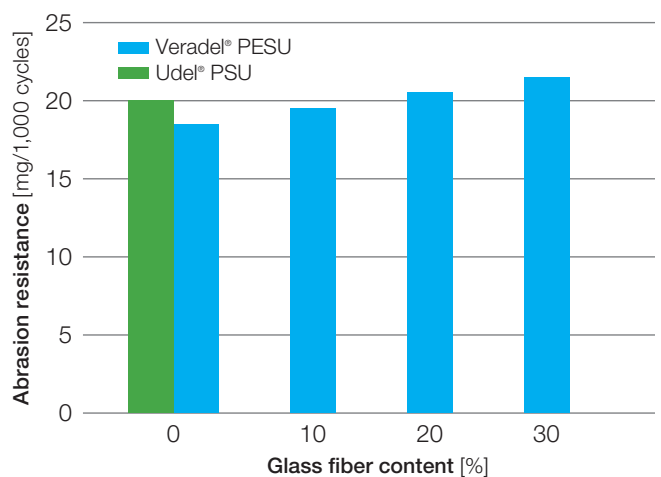

Long-Term Properties

The mechanical properties of materials are affected by strain rate and load application mode. These effects may be more important with polymeric materials than with metals, but the consequences are similar. The designer must be aware that constant stress will result in more deformation than expected from the short-term modulus. The user must also be cognizant of the effect of cyclic loading. This section presents the available information on creep and fatigue.

Creep

When a bar made of a polymeric material is continuously exposed to a constant stress, its dimensions will change in response to the stress. This phenomenon is commonly called “creep.” In the simplest case, the tensile mode, the test bar will elongate as a function of time under stress. The term “strain” is used for the amount of length increase or elongation divided by the initial length.

Creep can also be observed and measured in a bending or flexural mode, or in a compressive mode. In the flexural mode, the strain is the amount the surface on the outside of the bend must stretch. In the compressive mode, the test bar will actually get smaller and the strain is the amount of shortening.

The creep information presented in this manual was developed using the tensile mode.

Creep modulus

When a component is being designed, the short-term properties such as strength, stiffness, and impact resistance are always considerations. Normally the maximum deformation is also calculated because deformation impacts component function. When the component is subjected to constant or long-term stress, the deformations will be greater than those predicted from the short-term properties.

To more accurately predict deformations, the creep modulus is useful. The creep modulus is derived by dividing the applied stress by the measured strain after exposure to load for a specified time. Using the creep modulus gives more accurate prediction of deformation values after long-term exposure to stress.

Figure 27 presents the modulus data obtained when Veradel® PESU was tested at 20.7 MPa (3,000 psi) stress as a function of time. The amount of dimensional change or creep is also a function of temperature. As the test temperature is increased, the modulus is decreased.

Figure 27: Creep modulus Veradel® A-201 at 20.7 MPa (3,000 psi)

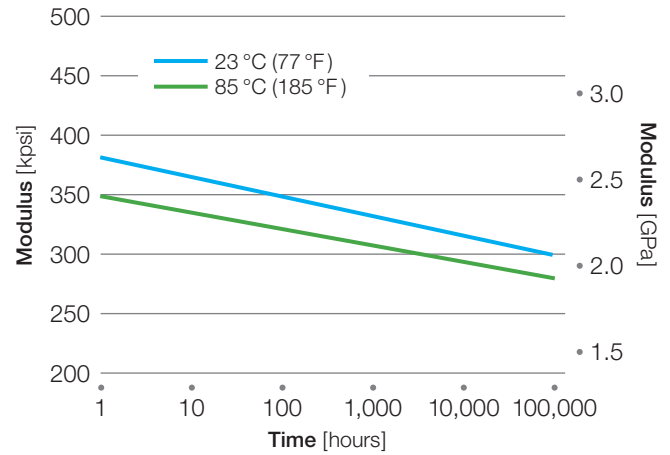

The creep modulus data for Radel® PPSU are shown in Figure 28. Radel® PPSU resin has surprisingly good creep resistance, especially at elevated temperature.

Figure 28: Creep modulus Radel® R-5000 at 20.7 MPa (3,000 psi)

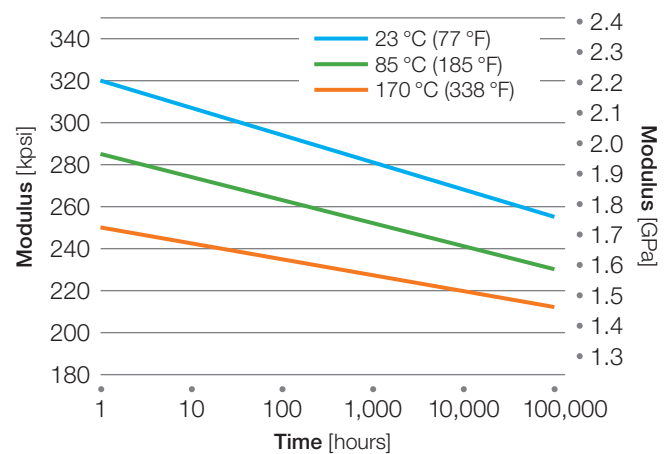

Isochronous stress-strain curves

Another way of presenting creep data is the isochronous stress/strain diagram. To prepare an isochronous diagram, the strains obtained after a specified time interval are plotted. This method has the advantage of providing a concise summary of a large amount of data. The apparent modulus at any point can be calculated by dividing the stress by the strain obtained (please note that the Figures show strain expressed in percent; actual strain is the plotted value divided by 100).

Figure 29 shows the stress/strain curves for Veradel® PESU at 100 hours of constantly applied load. The apparent modulus at any point can be calculated by dividing the stress by the indicated strain. Figure 30 presents the isochronous curves for neat Radel® PPSU under the same conditions.

Figure 29: Isochronous stress-strain curve Veradel® A-201 at 100 hours

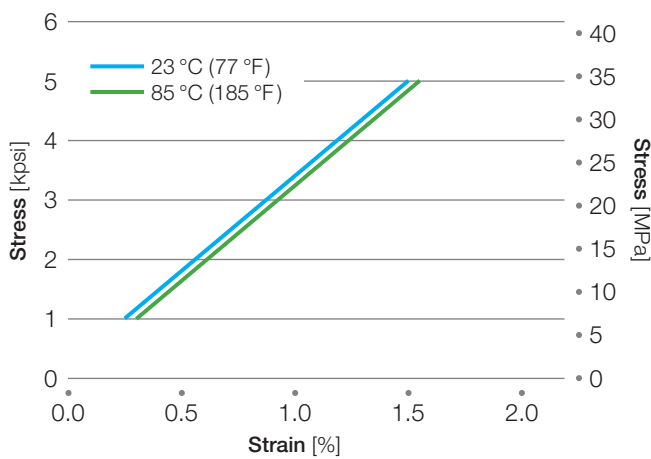
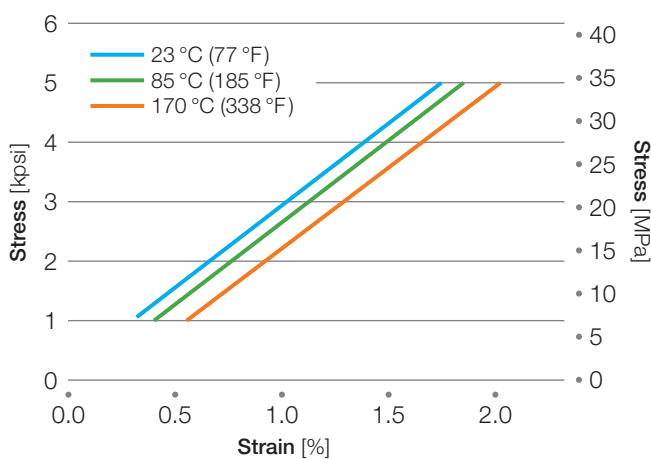

Figure 30: Isochronous stress-strain curve Radel® R-5000 at 100 hours



Fatigue

When a material is stressed cyclically, failure or rupture will occur at stress levels much lower than the short-term ultimate strength. A good example of an application involving cyclical stress is a gear. As the driving gear rotates and causes the driven gear to rotate, each tooth is subject to stress and in turn, followed by a period of time at low or zero stress until that tooth is engaged again. Many applications have a fatigue aspect, where the cyclic loading is not as evident. Other examples are bushings guiding a rotating shaft, parts subject to vibration, or any rotating part in a pump or compressor.

This phenomenon is well known in metals, and metallurgists have defined the term “Fatigue Endurance Limit” to represent the maximum cyclical stress that a material can be subjected to and still have infinite life. Normally, this stress level corresponds to the highest stress level that does not cause failure in 10 million (10^7) load cycles. While the term “Fatigue Endurance Limit” is sometimes used in design discussions involving plastic materials, the response of plastics to cyclical stress is more complex than the response of metals, and an endurance limit is not strictly defined.

When measuring and/or comparing the fatigue strength of plastic materials, it is critical to specify the mode (tensile, compressive, or flexural), the frequency, and the stress profile. The fatigue endurance data were generated using test method ASTM D671. This method uses a cantilever beam configuration with a constant amplitude of force. Specifically, the test specimen was type “A,” the frequency was 30 Hz, and the machine was the Sontag Universal Testing Machine, Model SF-01-U.

The flexural fatigue endurance curves for both neat and glass-reinforced grades of Veradel® PESU are shown in Figure 31. While these tests were run on the Veradel® A-201 series resins, the A-301 series resins are expected to give similar results.

Figure 31: Flexural fatigue endurance of Veradel® A-201 at 30 Hz

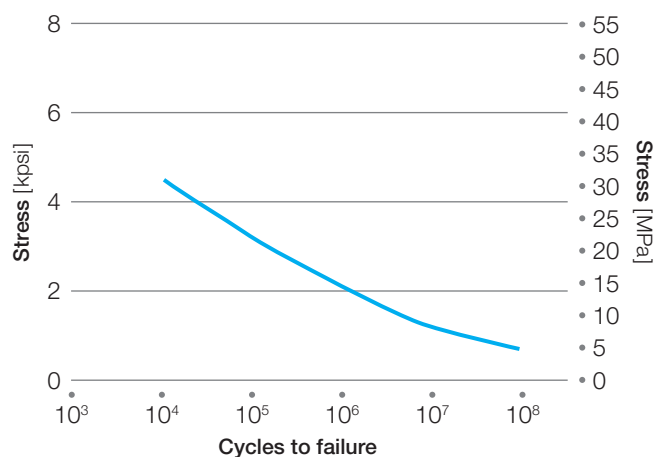

Thermal Properties

How a material responds to changing ambient temperatures are considered its thermal properties. These include changes in strength and stiffness; changes in dimensions; chemical changes due to thermal or oxidative degradation; softening, melting, or distortion; changes in morphology; and simple changes in temperature. The properties of the materials while molten are discussed in the processing section, and the behavior of these materials while burning is discussed in the combustion properties section.

Glass Transition Temperature

Typically, when a polymer is heated it will become progressively less stiff until it reaches a rubbery state. The temperature at which the material goes from a glassy to a rubbery state is defined as the glass transition temperature (T_g). This temperature is important because several fundamental changes occur at this temperature. These include changes in polymer free volume, refractive index, enthalpy, and specific heat. The following Table lists the glass transition temperatures of Radel® PPSU, Veradel® PESU and Udel® PSU. The glass transition temperatures of Radel® PPSU and Veradel® PESU resins are 35 °C (63 °F) higher than that of Udel® PSU. This difference translates into extended thermal capability.

Table 15: Glass transition temperatures

Glass Transition Temperatures	
Material	[°C (°F)]
Radel® PPSU	220 (428)
Veradel® PESU	220 (428)
Udel® PSU	185 (365)

Glass transition temperature is defined as the onset of change in heat capacity as measured by differential scanning calorimetry. Typically, the measured value is rounded to the nearest 5 °C.

Mechanical Property Changes

As ambient temperatures are increased, thermoplastics become softer and softer until they become fluid. Prior to that point, the softening can be monitored by plotting the elastic modulus versus the ambient temperature.

Classification of thermoplastic resins

Thermoplastics are often divided into two classes: amorphous and semi-crystalline. Figure 32 shows in a generalized manner the difference in temperature response between these resin types. The modulus of amorphous resins generally decreases slowly with increasing temperature until the glass transition temperature (T_g) is reached. Amorphous resins are not normally used at ambient temperatures higher than their glass transition temperature.

The modulus of semi-crystalline resins generally follows the behavior of amorphous resins up to the glass transition temperature. At T_g , the modulus shows a rapid decrease to a lower level, but remains at or near the new level until the melting point (T_m) is reached. Semi-crystalline resins are often used in ambient temperatures above their glass transition temperatures, but below their melting points.

Figure 32: Typical change in modulus with temperature

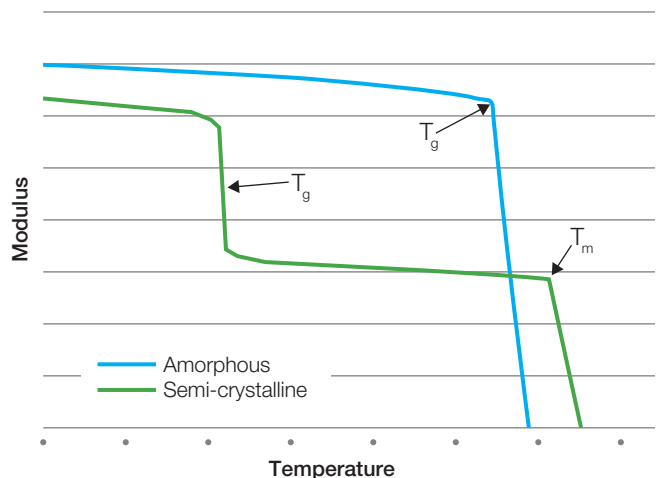

Temperature effects on modulus

Radel® PPSU, Veradel® PESU and Udel® PSU are all amorphous resins. The effects of temperature upon their flexural moduli can be seen in Figure 33.

Figure 33: Flexural modulus vs. temperature of neat resins

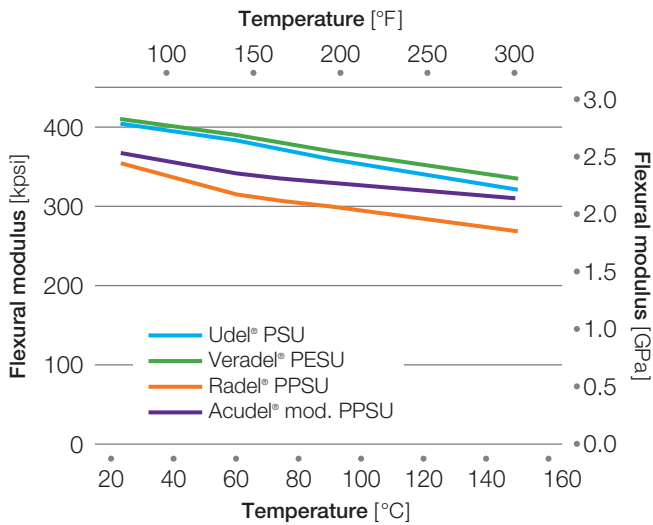

Of the three sulfone polymers, Veradel® PESU has the highest initial modulus and also the highest modulus at elevated temperature.

Temperature effects on tensile strength

As a material loses stiffness due to rising ambient temperature, it also loses strength. Figure 34 shows the effect of temperature on the tensile strength of the neat polysulfones.

Figure 34: Tensile strength vs. temperature of neat resins

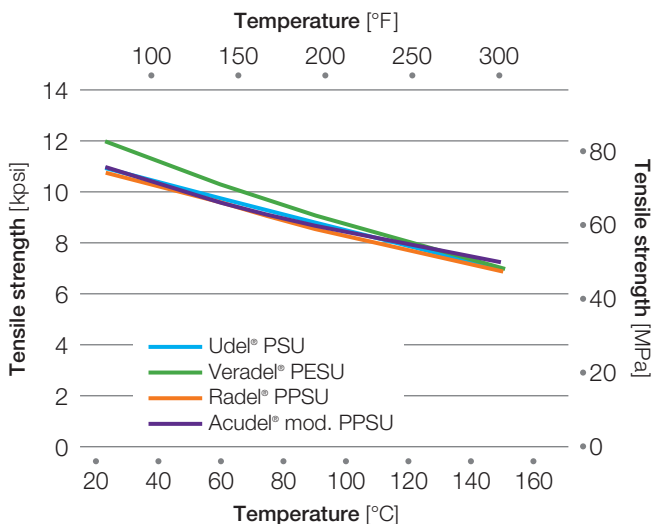

Deflection Temperature Under Load

One measure of short-term thermal capability is the deflection temperature under flexural load test described in ASTM D648. In this test, a 127 mm (5 in.) bar is placed on supports that are 102 mm (4 in.) apart. The bar is loaded to a fiber stress of either 0.45 MPa (66 psi) or 1.8 MPa (264 psi). The vertical deformation is monitored while the temperature is increased at a specified rate. When the vertical deformation reaches the specified end point of 0.25 mm (0.010 in.), the temperature is noted and reported as the Heat Deflection Temperature, or HDT. This test actually measures the temperature at which the flexural modulus is approximately 240 MPa (35,000 psi) when the test stress is 0.45 MPa (66 psi), or 965 MPa (140,000 psi) when the stress is 1.8 MPa (264 psi).

Testing variables

Certain test parameters can have a significant influence upon the results, and the designer should be aware of these effects. These test parameters are specimen thickness and thermal history. The test specimens for this test are injection molded, rectangular-cross-section bars, either 3.2 mm (0.125 in.) or 6.4 mm (0.25 in.) thick. The test may be performed as-molded or after heat treating or annealing. Annealing conditions are one hour at 170°C (338°F) for Udel® PSU or 200°C (392°F) for Veradel® PESU or Radel® PPSU resins.

Molding conditions will affect molded-in stress levels, and therefore the apparent deflection temperature of the as-molded bars. Annealing relieves molded-in stress and generally causes the measured deflection temperature to increase. The difference in deflection temperature between as-molded and annealed test specimens is a function of the amount of molded-in stress, which is usually higher when the thinner bar is used. Because the measured deflection temperature varies with the amount of molded-in stress, annealing is often used to provide a more reproducible value. The annealed value more accurately reflects the thermal capability of a resin than the as-molded value.

Annealing and specimen thickness effects are seen to a greater extent with neat resins. The results obtained with glass-filled resins are less affected by these variables.

Heat deflection temperature comparisons

Both Radel® PPSU and Veradel® PESU have improved thermal capability compared to Udel® PSU.

Table 16 contains the deflection temperature data for neat Radel® PPSU, Veradel® PESU and Acudel® mod. PPSU resins, and for glass-filled Veradel® PESU at both stress levels, for 3.2 mm (0.125 in.) bar thickness annealed, and glass-filled Radel® PPSU resin.

Table 16: Deflection temperatures of Radel® PPSU, Veradel® PESU and Acudel® mod. PPSU resins

Grade	Stress	
	0.45 MPa (66 psi) [°C (°F)]	1.82 MPa (264 psi) [°C (°F)]
Radel® PPSU		
R-5000	214 (417)	207 (405)
RG-5030		210 (410)
Veradel® PESU		
A-201, A-301	214 (417)	204 (399)
AG-320	218 (424)	214 (417)
AG-330	220 (428)	216 (420)
Acudel® mod. PPSU		
22000		197 (387)

Figure 35 compares the heat deflection temperatures of neat Udel® PSU, Veradel® PESU, Radel® PPSU, and Acudel® mod. PPSU. Both Radel® PPSU and Veradel® PESU resins have heat deflection temperatures that are about 30 °C (55 °F) higher than that of polysulfone. The heat deflection temperature of Radel® PPSU is about 3 °C (5 °F) higher than that of Veradel® PESU.

Figure 35: Deflection temperature of neat resins at 1.8 MPa (264 psi)

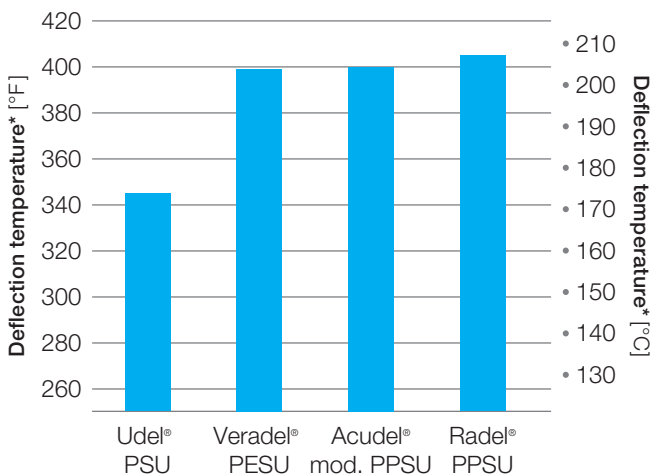

Thermal Expansion Coefficient

As temperatures rise, most materials increase in size. The magnitude of the size increase is given by the following:

$$DL = aL_0DT$$

Where L_0 is the original length, and DL and DT are the change in length and temperature respectively.

The coefficient of linear thermal expansion (a) was measured in accordance with ASTM D696.

The coefficients of linear thermal expansion for Radel® PPSU, Veradel® PESU and Acudel® mod. PPSU resins as well as some common metals are shown in Table 17. Thermal stresses will be induced in assemblies when materials with different expansion coefficients are joined. The values shown in Table 17 should allow the design engineer to calculate the magnitude of any thermal stresses arising from thermal expansion.

Table 17: Coefficient of linear thermal expansion*

Material	CLTE [$\mu\text{m}/\text{m}^\circ\text{C}$ ($\mu\text{in}/\text{in}^\circ\text{F}$)]
Veradel® A-201	49 (27)
Veradel® AG-320	31 (17)
Veradel® AG-330	31 (17)
Radel® R-5000	56 (31)
Radel® RG-5030	18 (10)
Acudel® 22000	63 (35)
Zinc die-casting alloy	27 (15)
Aluminum die-casting alloy	25 (14)
Stainless steel	18 (10)
Carbon steel	14 (8)

*Measured in the flow direction

Thermal Conductivity

Polymers in general are poor conductors of heat. For many applications, this is desirable because the polymer provides a measure of thermal isolation. Table 18 shows the relative thermal conductivities, as measured by ASTM E1530, of Radel® PPSU, Veradel® PESU, Acudel® mod. PPSU, and Udel® PSU resins as well as some other common materials.

Table 18: Thermal conductivity

Material	Thermal Conductivity [W/m·K (Btu·in./hr·ft²F)]
Udel® P-1700	0.26 (1.80)
Veradel® A-201	0.24 (1.66)
Veradel® AG-330	0.30 (2.08)
Radel® R-5000	0.30 (2.08)
Acudel® 22000	0.24 (1.66)
Stainless steel	20–36 (140–250)
Carbon	5–9 (36–60)
Wood (Particle board)	1.7 (12)
Rubber	0.14 (1.00)

Specific Heat

Specific heat is defined as the amount of heat required to change the temperature of a unit mass one degree. This property was measured using ASTM E1269. Figure 36 shows that the specific heat of Radel® PPSU and Veradel® PESU resins is a function of temperature, and that the specific heat changes significantly at the glass transition temperature. The specific heat of Acudel® mod. PPSU also changes with temperature but do so more gradually.

Figure 36: Specific heat

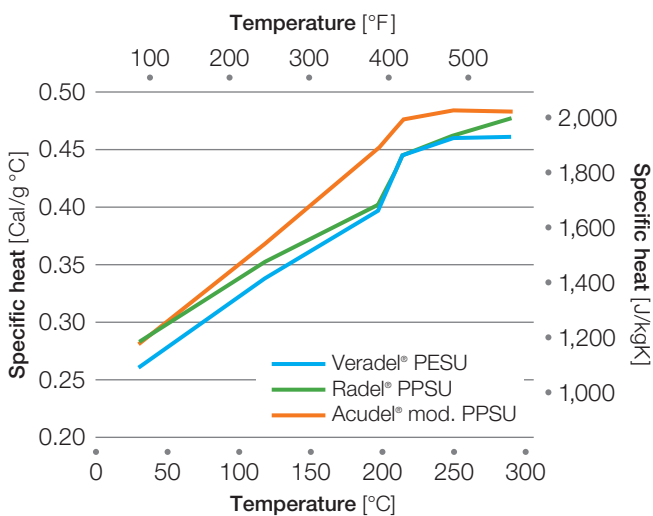

Combustion Properties

UL-94

Veradel® PESU neat resins are rated V-0 at a specimen thickness of 1.6 mm (0.062 in.). The glass-reinforced grades are rated V-0 at a specimen thickness of 0.8 mm (0.031 in.). Radel® PPSU grades R-5000, R-5100, and R-5500 are all rated V-0 at a specimen thickness of 0.8 mm (0.031 in.).

Oxygen index

The oxygen index is defined by ASTM D2863 as the minimum concentration of oxygen, expressed as volume percent, in a mixture of oxygen and nitrogen that will support flaming combustion of a material initially at room temperature under the conditions of this method.

Since ordinary air contains roughly 21% oxygen, a material whose oxygen index is appreciably higher than 21 is considered flame resistant because it will only burn in an oxygen-enriched atmosphere. Radel® PPSU, Acudel® mod. PPSU and Veradel® PESU resins are inherently flame resistant as shown by the oxygen indices in Table 19.

Table 19: Oxygen indices of Radel® PPSU, Veradel® PESU and Acudel® mod. PPSU resins

Material	Oxygen Index
Veradel® AG-320 (20% glass)	40
Veradel® AG-330 (30% glass)	40
Radel® R-5000	44
Acudel® 22000	38

Self-ignition temperature

The self-ignition temperature of a material is defined as the lowest ambient air temperature at which, in the absence of an ignition source, the self-heating properties of the specimen lead to ignition or ignition occurs of itself, as indicated by an explosion, flame, or sustained glow. This property was measured using ASTM D1929.

The self-ignition temperature of Veradel® PESU is 502 °C (936 °F).

Smoke density

When a material burns, smoke is generated. The quantity and density of the generated smoke is important in many applications. ASTM E662 provides a standard technique for evaluating relative smoke density. This test was originally developed by the National Bureau of Standards (NBS), and is often referred to as the NBS Smoke Density test.

The data presented in Table 20 were generated using the flaming condition. A six-tube burner was used to apply a row of flamelets across the lower edge of the specimen. A photometric system aimed vertically is used to measure light transmittance as the smoke accumulates. The specific optical density (D_s) is calculated from the light transmittance. The maximum optical density is called D_m .

Table 20: Smoke density

Measurement	Veradel® PESU	Radel® PPSU
D_s at 1.5 minutes	0	0.3
D_s at 4.0 minutes	1.0	0.4
D_m	5–15	35

Specimen thickness = 1.6 mm (0.063 in.)

These data show that both Radel® PPSU and Veradel® PESU are extremely low smoke generators.

Thermal Stability

Thermogravimetric analysis

One method for evaluating the thermal stability of a material is thermogravimetric analysis. In this test, a small sample of the test material is heated while its weight is constantly monitored. The test is usually run with both an inert nitrogen atmosphere and in air. The difference in the results indicates the importance of oxygen in causing degradation.

Figures 37 and 38 show the thermogravimetric analysis results obtained using a heating rate of 10 °C (18 °F) per minute for Radel® PPSU, Veradel® PESU and Udel® PSU in nitrogen and in air respectively. The results show that all five resins have exceptional thermal stability. There is no significant weight loss below 427 °C (800 °F) which is over 28 °C (50 °F) higher than the maximum recommended processing temperature.

Figure 37: Thermogravimetric analysis in nitrogen

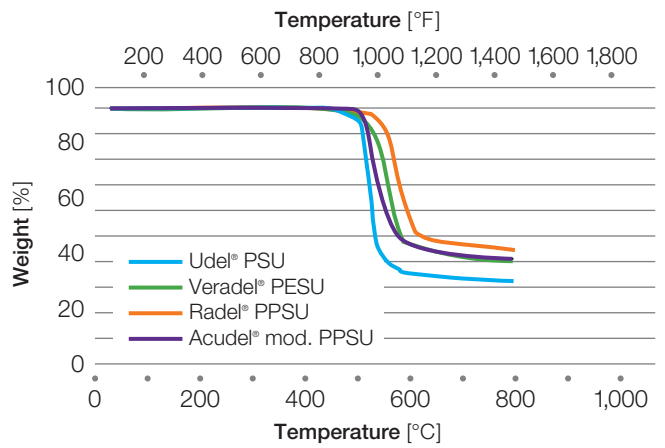

Figure 38: Thermogravimetric analysis in air

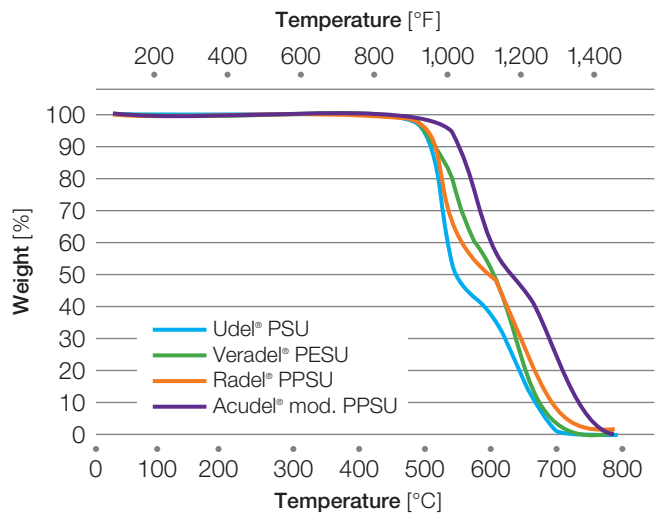

Table 21 gives the temperature at which the listed weight losses were recorded. These data clearly show that Radel® PPSU has the best thermal stability of the resins tested.

Table 21: Thermogravimetric analysis details

Material	Weight Loss			
	1% [°C (°F)]	2% [°C (°F)]	5% [°C (°F)]	10% [°C (°F)]
Temperature in nitrogen				
Udel® PSU	480 (896)	489 (912)	500 (932)	509 (948)
Veradel® PESU	472 (882)	487 (909)	511 (952)	530 (986)
Radel® PPSU	504 (939)	519 (966)	541 (1006)	556 (1033)
Acudel® mod. PPSU	491 (916)	498 (928)	512 (954)	521 (970)
Temperature in air				
Udel® PSU	470 (878)	487 (909)	502 (936)	513 (955)
Veradel® PESU	472 (882)	487 (909)	506 (943)	525 (977)
Radel® PPSU	496 (925)	514 (957)	537 (999)	558 (1036)
Acudel® mod. PPSU	476 (888)	491 (916)	508 (946)	519 (966)

Thermal aging

Thermo-oxidative stability limits the acceptable long-term use temperature of polymers. To evaluate the long-term effects of elevated ambient temperatures on the properties of Veradel® PESU, test specimens were oven aged at several different temperatures. Bars were periodically removed and tested at room temperature for tensile strength. Figure 39 shows the results of this testing on neat Veradel® PESU resin. Data on polyetherimide (PEI) are included for comparison. Veradel® PESU is more thermally stable than polyetherimide.

Figure 39: Thermal aging of Veradel® PESU and PEI

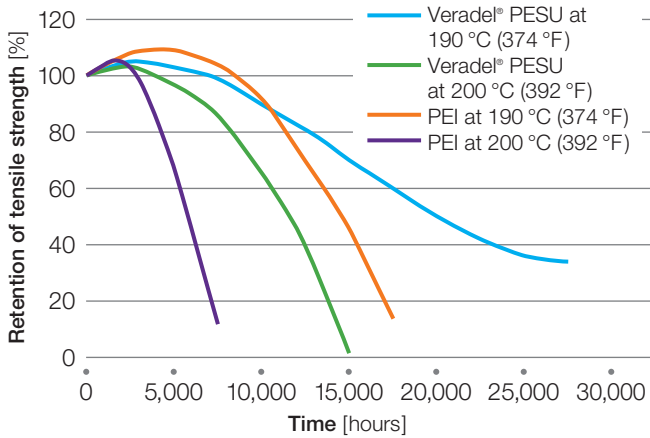

The evaluation of the thermal aging characteristics of Radel® PPSU resins is in progress. The results obtained so far are shown in Figure 40. It is evident that the greater thermal stability of Radel® PPSU seen in TGA is also seen in these aging tests.

Figure 40: Thermal aging of Radel® PPSU

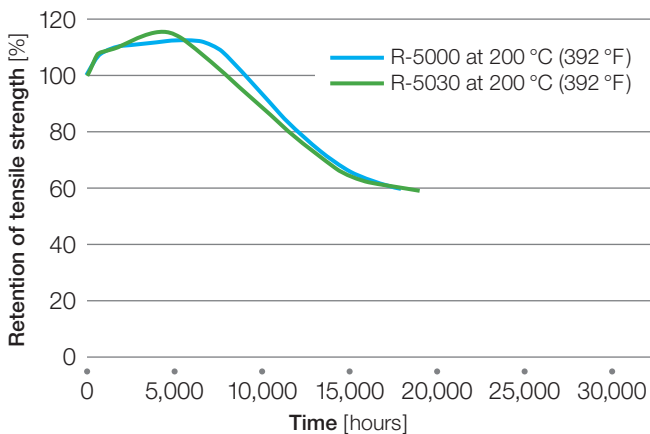

UL relative thermal index

Thermal aging data similar to that appearing in the previous section are used to establish Relative Thermal Indices (RTI) per Underwriters Laboratories Standard 746B. This method determines the temperature to which a material can be exposed for 100,000 hours and still retain fifty percent of its original properties. The index temperature is frequently considered the maximum continuous use temperature. Table 22 gives the indices that have been assigned to Radel® PPSU and Veradel® PESU by Underwriters Laboratories. For the most current and complete information, please consult the Underwriters Laboratories website at www.ul.com.

Table 22: Relative thermal index per UL 746B

Grade	Thickness [mm (inch)]	Electrical [°C]	Mechanical Impact [°C]	Mechanical Strength [°C]
Radel® PPSU				
R-5000	0.75 (0.030)	160	160	160
	1.5 (0.059)	160	160	160
	3.0 (0.118)	160	160	160
R-5100	0.36 (0.014)	160	160	160
	0.75 (0.030)	160	160	160
	1.5 (0.059)	160	160	160
R-5500	0.79 (0.031)	160	160	160
	3.0 (0.118)	160	160	160
R-5800	0.75 (0.030)	160	160	160
	1.5 (0.059)	160	160	160
	3.0 (0.118)	160	160	160
Veradel® PESU				
A-201	0.8 (0.032)	180	170	180
	1.5 (0.059)	180	170	180
	3.0 (0.118)	180	170	180
A-301	0.8 (0.032)	180	170	180
	1.5 (0.059)	180	170	180
	3.0 (0.118)	180	170	180
A-702	1.5 (0.059)	180	170	180
	3.0 (0.118)	180	170	180

Electrical Properties

Many applications for thermoplastic resins depend upon their ability to function as electrical insulators. Several tests have been developed to provide the designer with measures of how well a particular resin can perform that function.

Dielectric Strength

Dielectric strength is a measure of a material's ability to resist high voltage without dielectric breakdown. It is measured by placing a specimen between electrodes and increasing the applied voltage through a series of steps until dielectric breakdown occurs. Although the results have units of kV/mm (volts/mil), they are not independent of sample thickness. Therefore, data on different materials are comparable only for equivalent sample thicknesses.

Volume Resistivity

Volume resistivity is defined as the resistance of a unit cube of material. The test is run by subjecting the material to 500 volts for one minute and measuring the current. The higher the volume resistivity, the more effective a material will be in electrically isolating components.

Dielectric Constant

Dielectric constant is defined as the ratio of the capacitance of a condenser using the test material as the dielectric to the capacitance of the same condenser with a vacuum replacing the dielectric. Insulating materials are used in two very distinct ways: (1) to support and insulate components from each other and ground, and (2) to function as a capacitor dielectric. In the first case, it is desirable to have a low dielectric constant. In the second case, a high dielectric constant allows the capacitor to be physically smaller.

Dissipation Factor

Dissipation Factor (also referred to as loss tangent or tan delta) is a measure of the dielectric loss (energy dissipated) of alternating current to heat. In general, low dissipation factors are desirable.

UL-746A Short-Term Properties

Certain electrical properties are included in the Underwriters Laboratories' Standard 746A, entitled Standard for Polymeric Materials Short-Term Property Evaluations and are typically reported by Performance Level Class. For each test, UL has specified test result ranges and the corresponding performance level class. Desired or best performance is assigned to a PLC of 0, therefore the lower the number, the better the material's performance.

High-voltage, low-current dry arc resistance

This test measures the time that an insulating material resists the formation of a conductive path due to localized thermal and chemical decomposition and erosion. The test, ASTM D495, is intended to approximate service conditions in alternating-current circuits operating at high voltage with currents generally limited to less than 0.1 ampere.

Comparative Tracking Index (CTI)

This test determines the voltage that causes a permanent electrically conductive carbon path when 50 drops of electrolyte is applied to the specimen at the rate of one drop every 30 seconds. This test is used as a measure of the susceptibility of an insulating material to tracking.

High-Voltage Arc – Tracking Rate (HVTR)

This test determines the susceptibility of an insulating material to track or form a visible carbonized conducting path over the surface when subjected to high-voltage, low-current arcing. The high-voltage arc-tracking rate is the rate in millimeters per minute at which a conducting path can be produced on the surface of the material under standardized test conditions.

Hot Wire Ignition (HWI)

This test determines the resistance of plastic materials to ignition from an electrically heated wire. Under certain operational or malfunctioning conditions, components become abnormally hot. When these overheated parts are in intimate contact with the insulating materials, the insulating materials may ignite. The intention of the test is to determine the relative resistance of insulating materials to ignition under such conditions.

High-Current Arc Ignition (HAI)

This test measures the relative resistance of insulating materials to ignition from arcing electrical sources. Under certain conditions, insulating materials may be in proximity to arcing. If the intensity and duration of the arcing are severe, the insulating material can ignite.

Table 23: Electrical properties of Radel® PPSU, Veradel® PESU and Acudel® mod. PPSU resins

Material	Dielectric Strength ASTM D149 [kV/mm (volts/mil)]	Volume Resistivity ASTM D257 [ohm·cm]	Dielectric Constant ASTM D150			Dissipation Factor ASTM D150		
			60 Hz	1 KHz	1 Mhz	60 Hz	1 Hz	1 Mhz
Veradel® PESU								
A-201A, A-301A	15 (380)	$1.7 \cdot 10^{15}$	3.51	3.50	3.54	0.0017	0.0022	0.0056
AG-320	17 (440)	$>10^{16}$	3.84	3.84	3.88	0.0015	0.0018	0.0081
AG-330	17 (440)	$>10^{16}$	4.11	4.11	4.17	0.0019	0.0018	0.0094
Radel® PPSU								
R-5000, R-5100, R-5500, R-5800	15 (380)	$9 \cdot 10^{15}$	3.44	3.45	3.45	0.0006		0.0076
Acudel® mod. PPSU								
Acudel® 22000	18 (470)	$>9 \cdot 10^{15}$			3.40			0.0080

Table 24: Electrical properties of Radel® PPSU and Veradel® PESU resins per UL-746A*

Material	Thickness [mm (inch)]	D 495 Scale* 0-7		CTI Scale* 0-5		HVTR Scale* 0-4		HWI Scale* 0-5		HAI Scale* 0-4	
		[arcs]		[volts]		[mm/min]		[sec]		[arcs]	
Veradel® PESU											
A-201, 301	0.8 (0.031)					147	3	13	4	13	4
	1.6 (0.062)					99	3	25	3	11	4
	3.2 (0.125)	94	6	155	4	97	3	85	1	20	3
AG-320	0.8 (0.031)							13	4	4	4
	1.6 (0.062)							25	3	4	4
	3.2 (0.125)	94	6	140	4	97	4	85	1	4	4
AG-330	0.8 (0.031)							48	2	4	4
	1.6 (0.062)							77	1	4	4
	3.2 (0.125)	121	6	140	4	203	4	96	1	4	4
Radel® PPSU											
R-5000	0.8 (0.031)							> 150	0	> 150	0
	3.2 (0.125)	135	5	62	5	0	0				

* 0 = best

Environmental Resistance

Hydrolytic Stability

Hydrolytic stability can be defined as resistance to hydrolysis, or attack by water. Therefore, hydrolytic stability is a specific instance of chemical resistance. Hydrolytic stability has special importance because water is ubiquitous and is very aggressive to many polymers. A quick test for hydrolytic stability is immersion in boiling water. As shown in Table 25, polysulfones have excellent resistance to hydrolysis. Of the sulfone polymers, Radel® PPSU has exceptional performance.

Table 25: Resistance to boiling water*

Grade	Tensile Strength [%]	Tensile Elongation [%]
Udel® PSU	113	21
Veradel® PESU	94	8
Radel® PPSU	99	105

* Retention of properties after 10 days

Hydrolytic stability is very important in plumbing applications and a longer-term study of the effects of prolonged hot water exposure on Radel® R-5000 and Acudel® 22000 was conducted. Mechanical properties of the two resins as-molded were determined. Test specimens molded from these materials were then exposed to 60°C (140°F) and 90°C (194°F) water for periods up to 8,000 hours (333 days). After exposure, the mechanical properties of these specimens were tested. The percent retention of each property was calculated by dividing the final value by the value before exposure and multiplying by 100.

The results of this study are summarized in Table 26. The properties of both Radel® R-5000 and Acudel® 22000 were generally unaffected by the hot water exposure. The only property showing a significant decrease is elongation at break, which could be interpreted as an indication of embrittlement. However, the tests of impact strength show good retention of impact strength indicating that practical toughness is maintained.

Table 26: Effects of prolonged hot water exposure*

Property	Acudel® 22000	Radel® R-5000
	60°C (140°F)	90°C (194°F)
Tensile strength	100.0	104.7
Tensile modulus	90.2	91.9
Elongation at yield	92.5	85.0
Elongation at break	56.9	34.7
Flexural strength	100.9	105.5
Flexural modulus	108.2	111.6
Notched Izod	64.3	53.6
Instrumented drop impact	112.9	114.5

* Retention of properties after 16,000 hours

Steam sterilization analysis

Because steam autoclaves are widely used to sterilize medical devices, resistance to steam sterilization is important for applications in medical devices.

To evaluate this property in a manner consistent with actual practice, morpholine was added to the steam to simulate the presence of typical boiler additives, and the test bars were strained in a cantilever beam arrangement to an outer fiber stress of 1,000 psi (6.9 MPa) to simulate residual or molded-in stresses commonly found in most components.

The testing was conducted in a steam autoclave at 2 bar (27 psig) steam which has a temperature of 132°C (270°F). The steam contains morpholine, a commonly used boiler corrosion inhibitor, at a concentration of 50 ppm. The specimens were molded bars with dimensions of 127 × 13 × 3 mm (5 × 0.5 × 0.125 in.). The results of the evaluation are shown in Table 27.

Table 27: Steam autoclave resistance

Grade	Cycles to Craze	Cycles to Rupture
Udel® PSU	80	150
Veradel® PESU	100	275
Radel® PPSU	>1,000*	>1,000*

* Testing stopped at 1,000 cycles; neither crazing nor rupture occurred.

Chemical Resistance

In general, sulfone resins have reasonably good chemical resistance, especially to aqueous systems. Table 28 gives a general indication of the relative chemical resistance to a variety of common reagents. The resistance of both the sulfone family of resins and polyetherimide resin to aqueous acids is excellent. The sulfone polymers also resist aqueous caustic solutions which severely attack polyetherimide.

Table 28: General indication of chemical resistance*

Reagent	Udel® PSU	Veradel® PESU	Radel® PPSU	PEI
n-Butane	G	E	E	E
Iso-Octane	G	E	E	E
Benzene	P	P	F	P
Toluene	P	P	F	P
Ethanol	G	E	E	E
Methyl ethyl ketone	P	P	P	F
2-Ethoxyethanol	P	P	G	F
1,1,1-Trichloroethane	P	P	G	F
Carbon tetrachloride	P	G/E	E	E
Hydrochloric acid, 20%	E	E	E	E
Acetic acid, 20%	E	E	E	E
Sulfuric acid, 20%	E	E	E	E
Sodium hydroxide, 10%	E	E	E	P

* Exposure: immersion for seven days at room temperature.

Rating System

E = Excellent: Little or no effect

G = Good: No serious loss of properties

F = Fair: Some negative effects, some useful properties retained

P = Poor: Severe attack or rupture

Radel® PPSU also exhibits excellent resistance to chlorinated water at elevated temperatures. Exposure to a 90 °C (194 °F) re-circulating water environment with 5 ppm free chlorine for 1,500 hours did not produce any reduction in resin tensile strength or in the weight of the test bars. Other engineering resins, including nylon 6,6 and an aliphatic polyketone showed substantial weight losses under similar testing.

Some chlorinated hydrocarbons are solvents for the sulfone polymers and polyetherimide, while others can cause environmental stress cracking to varying degrees. In general this class of chemicals is incompatible with these resins. However, Radel® PPSU offers the best resistance profile.

Aromatic solvents and oxygenated solvents, such as ketones and ethers, can cause stress cracking in both sulfone polymers and polyetherimide. Radel® PPSU exhibits the best resistance within this group of resins. Glass fiber reinforced grades of Radel® PPSU resin can often be used in many of these environments without stress cracking.

Radel® PPSU chemical resistance

Because screening tests indicate that Radel® PPSU has exceptional chemical resistance, more extensive testing was performed. Samples of Radel® PPSU were immersed in a variety of reagents for seven days at room temperature. The effects of the exposure were monitored by measuring any change in weight and noting any change in appearance. The results of that evaluation are shown in Table 29 on page 30. To summarize these data, Radel® PPSU is not seriously affected by organic chemicals, except for ketones. Of the inorganic chemicals tested, only concentrated strong acids had a deleterious effect. Several functional fluids common in transportation were tested. Of these only Skydrol® 500B aircraft hydraulic fluid showed crazing.

Table 29: Chemical resistance of Radel® PPSU by immersion*

Reagent	Concentration [%]	Weight Change [%]	Comments
Organic chemicals			
1,1,1 Trichloroethane	100	+0.0	No change
Acetone	100	+9.0	Surface softened
Benzene	100	+0.7	Cloudy
Butanol	100	-0.0	No change
Butyl acetate	100	+0.0	No change
Carbitol solvent	100	-0.0	No change
Carbon tetrachloride	100	+0.0	No change
Cyclohexane	100	+0.0	No change
Ethanol	100	+0.3	Dark spots
Ethyl acetate	100	+3.7	Edges whitened
Ethylene glycol	100	-0.4	No change
Formaldehyde	40	+0.4	No change
Glycerol	100	-0.0	No change
Methanol	100	+0.9	Cloudy
Toluene	100	+0.8	Whitened
Acetic acid – glacial	100	+0.0	Slight attack
Acetic anhydride	100	+1.0	Crazed
Citric acid	100	+0.5	No change
Formic acid	10	+0.6	No change
Inorganic chemicals			
Hydrochloric acid	20	+0.2	No change
Hydrochloric acid	37	+0.2	Bleached
Nitric acid	20	+0.5	No change
Nitric acid	71	+26.9	Opaque cracked
Oleic acid	100	0.0	No change
Potassium hydroxide	10	+0.5	No change
Sodium hydroxide	10	+0.5	No change
Sulfuric acid	50	+0.1	No change
Sulfuric acid	97	-11.3	Etched
Functional fluids			
Brake fluid	100	-0.2	Cloudy
Gasoline	100	+0.1	No change
Hydraulic oil LO-1	100	+0.0	No change
Jet fuel JP-4	100	+0.0	Cloudy
Kerosene	100	+0.0	No change
Motor oil 10W-40	100	+0.0	Cloudy

* Seven days at room temperature

Stress crack resistance

To evaluate the resistance of Radel® PPSU resins to environmental stress cracking, test specimens 127 × 13 × 3.2 mm (5 × 0.5 × 0.125 in.) were clamped to curved fixtures. The radius of the fixture induces a strain in the specimen. The corresponding stress was calculated from the tensile modulus of the material. The reagents were then applied to the central portion of the fixtured test specimen. After 24 hours of exposure, the specimens were examined for evidence of attack and rated. Table 30 defines the ratings that appear in the subsequent environmental stress crack resistance Tables.

Table 30: Key to environmental stress cracking Tables

Symbol	Definition
OK	No change in appearance, no cracking, no softening, no discoloration
D	Dissolved, evidence of solvation, softening, or swelling
C	Crazing
R	Rupture

The results of this testing in automotive fluids is shown in Table 31 on page 36. Testing of organic chemicals is shown in Table 32 on page 37. Inorganic chemical results are in Table 33 on page 38, and aviation chemical results are in Table 34 on page 38.

The variables of importance in environmental stress cracking are temperature, stress level, time, and reagent. If a reagent causes stress cracking at a given time, temperature, and stress level, the following generalizations usually apply. At lower stress levels, cracking may not occur unless the exposure time is much longer or the temperature is higher. Higher temperatures generally speed cracking. Diluting the reagent may or may not eliminate stress cracking, depending upon the reagent and its miscibility with the diluent.

For the purpose of part design, it is important to consider the chemical environment, especially if the part will be stressed.

Radiation Resistance

Veradel® A-201 was exposed to gamma radiation at dosages of 4, 6, and 8 megarads. The properties of the exposed specimens were measured and compared to the properties of unexposed specimens. Veradel® PESU resin was virtually unaffected by the radiation, as shown in Figure 41.

Figure 41: Radiation resistance of Veradel® PESU

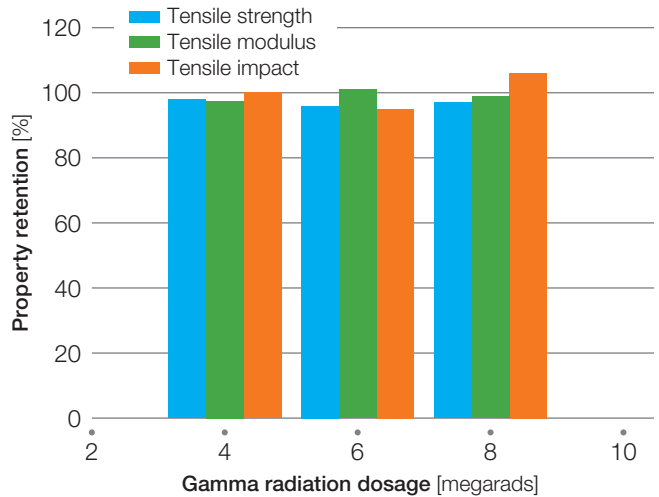

The gamma radiation resistance of Radel® PPSU was similarly evaluated using dosages of 5, 7.5, and 10 megarads. As shown in Figure 42, the radiation had virtually no effect on the Radel® PPSU even though a higher dosage was used.

Figure 42: Radiation resistance of Radel® PPSU

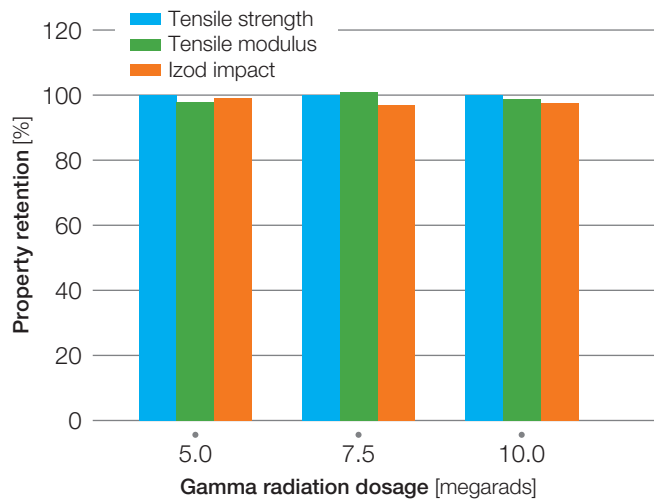

Table 31: Environmental stress cracking resistance to automotive fluids, 24 hours

Reagent	Concentration [%]	Temperature [°C (°F)]	Grade	Stress Level [MPa (psi)]			
				None	6.9 (1,000)	13.8 (2,000)	27.6 (4,000)
Antifreeze (Prestone®)	50	23 (73)	A-201	OK	OK	OK	OK
			AG-330	OK	OK	OK	OK
			R-5000	OK	OK	OK	OK
			RG-5030	OK	OK	OK	OK
	100	100 (212)	A-201	OK	OK	OK	OK
			AG-330	OK	OK	OK	OK
			R-5000	OK	OK	OK	OK
			RG-5030	OK	OK	OK	OK
	100	23 (73)	A-201	OK	OK	OK	OK
			AG-330	OK	OK	OK	OK
			R-5000	OK	OK	OK	OK
			RG-5030	OK	OK	OK	OK
	100	100 (212)	A-201	OK	OK	OK	OK
			AG-330	OK	OK	OK	OK
			R-5000	OK	OK	OK	OK
			RG-5030	OK	OK	OK	OK
Gasoline, unleaded	100	23 (73)	A-201	OK	OK	OK	C
			AG-330	OK	OK	OK	OK
			R-5000	OK	OK	OK	C
			RG-5030	OK	OK	OK	OK
Gasohol, 15 % Methanol	100	23 (73)	A-201	OK	OK	OK	C
			AG-330	OK	OK	OK	OK
			R-5000	OK	OK	OK	OK
			RG-5030	OK	OK	OK	OK
Motor oil 10 W-40	100	23 (73)	A-201	OK	OK	OK	OK
			AG-330	OK	OK	OK	OK
			R-5000	OK	OK	OK	OK
			RG-5030	OK	OK	OK	OK
	100	100 (212)	A-201	OK	OK	OK	OK
			AG-330	OK	OK	OK	OK
			R-5000	OK	OK	OK	OK
			RG-5030	OK	OK	OK	OK
Power steering fluid	100	23 (73)	A-201	OK	OK	OK	OK
			AG-330	OK	OK	OK	OK
			R-5000	OK	OK	OK	OK
			RG-5030	OK	OK	OK	OK
	100	100 (212)	A-201	OK	OK	OK	OK
			AG-330	OK	OK	OK	OK
			R-5000	OK	OK	OK	OK
			RG-5030	OK	OK	OK	OK
Reference fuel C	100	23 (73)	A-201	OK	OK	C	C
			AG-330	OK	OK	OK	OK
			R-5000	OK	OK	OK	C
			RG-5030	OK	OK	OK	OK
Transmission fluid	100	23 (73)	A-201	OK	OK	OK	OK
			AG-330	OK	OK	OK	OK
			R-5000	OK	OK	OK	OK
			RG-5030	OK	OK	OK	OK
	100	100 (212)	A-201	OK	OK	OK	OK
			AG-330	OK	OK	OK	OK
			R-5000	OK	OK	OK	OK
			RG-5030	OK	OK	OK	OK
Windshield washer concentrate	50	23 (73)	A-201	OK	OK	OK	OK
			AG-330	OK	OK	OK	OK
			R-5000	OK	OK	OK	OK
			RG-5030	OK	OK	OK	OK

Table 32: Environmental stress cracking resistance to organic chemicals, 24 hours

Reagent	Concentration [%]	Temperature [°C (°F)]	Grade	Stress Level [MPa (psi)]			
				None	6.9 (1,000)	13.8 (2,000)	27.6 (4,000)
Methyl ethyl ketone	100	23 (73)	A-201	R	R	R	R
			AG-330	D	D	D	D
			R-5000	D	R	R	R
			RG-5030	D	D	D	D
Trichloroethane 1,1,1	100	23 (73)	A-201	OK	C	R	R
			AG-330	OK	OK	OK	OK
			R-5000	OK	OK	OK	OK
			RG-5030	OK	OK	OK	OK
Toluene	100	23 (73)	A-201	C	R	R	R
			AG-330	OK	OK	OK	OK
			R-5000	OK	OK	C	C
			RG-5030	OK	OK	OK	OK
Methylene chloride	100	23 (73)	A-201	D	D	D	D
			AG-330	D	D	D	D
			R-5000	D	D	D	D
			RG-5030	D	D	D	D
Methanol	100	23 (73)	A-201	OK	OK	OK	OK
			AG-330	OK	OK	OK	OK
			R-5000	OK	OK	OK	OK
			RG-5030	OK	OK	OK	OK
Isopropanol	100	23 (73)	A-201	OK	OK	C	C
			AG-330	OK	OK	OK	OK
			R-5000	OK	OK	OK	OK
			RG-5030	OK	OK	OK	OK
Acetone	100	23 (73)	A-201	R	R	R	R
			AG-330	D	D	D	D
			R-5000	D	C	C	C
			RG-5030	D	D	D	D
Cellosolve (2-Ethoxyethanol)	100	23 (73)	A-201	C	C	C	C
			AG-330	OK	OK	OK	OK
			R-5000	OK	OK	C	C
			RG-5030	OK	OK	OK	OK
Carbitol (Diethylene glycol monoethyl ether)	100	23 (73)	A-201	C	C	R	R
			AG-330	OK	OK	OK	OK
			R-5000	OK	OK	C	C
			RG-5030	OK	OK	OK	OK

Table 33: Environmental stress cracking resistance to inorganic chemicals, 24 hours

Reagent	Concentration [%]	Temperature [°C (°F)]	Grade	Stress Level [MPa (psi)]			
				None	6.9 (1,000)	13.8 (2,000)	27.6 (4,000)
Sodium hydroxide	20	23 (73)	A-201	OK	OK	OK	OK
			AG-330	OK	OK	OK	OK
			R-5000	OK	OK	OK	OK
			RG-5030	OK	OK	OK	OK
	100 (212)	A-201	OK	OK	OK	OK	
		AG-330	OK	OK	OK	OK	
		R-5000	OK	OK	OK	OK	
		RG-5030	OK	OK	OK	OK	
Hydrochloric acid	20	23 (73)	A-201	OK	OK	OK	R
			AG-330	OK	OK	OK	OK
			R-5000	OK	OK	OK	OK
			RG-5030	OK	OK	OK	OK
	100 (212)	A-201		C	C	C	
		AG-330	OK	OK	OK	OK	
		R-5000	OK	OK	OK	OK	
		RG-5030	OK	OK	OK	OK	
Sulfuric acid	50	23 (73)	A-201	OK	OK	OK	OK
			AG-330	OK	OK	OK	OK
			R-5000	OK	OK	OK	OK
			RG-5030	OK	OK	OK	OK
	100 (212)	A-201	OK	OK	OK	OK	
		AG-330	OK	OK	OK	OK	
		R-5000	OK	OK	OK	OK	
		RG-5030	OK	OK	OK	OK	

Table 34: Environmental stress cracking resistance to aviation fluids, 24 hours

Reagent	Concentration [%]	Temperature [°C (°F)]	Grade	Stress Level [MPa (psi)]			
				None	6.9 (1,000)	13.8 (2,000)	27.6 (4,000)
Hydraulic fluid (Skydrol® 500B)	100	23 (73)	A-201	C	R	R	R
			AG-330	OK	OK	OK	OK
			R-5000	OK	OK	OK	OK
			RG-5030	OK	OK	OK	OK
Jet fuel A	100	23 (73)	A-201	OK	OK	OK	OK
			AG-330	OK	OK	OK	OK
			R-5000	OK	OK	OK	OK
			RG-5030	OK	OK	OK	OK
Aircraft deicer	100	23 (73)	A-201	OK	OK	OK	OK
			AG-330	OK	OK	OK	OK
			R-5000	OK	OK	OK	OK
			RG-5030	OK	OK	OK	OK

Physical Properties

Density

Plastic resins are sold by unit weight, but used volumetrically. The property that defines the relationship of volume and weight is density. The term specific gravity refers to a material's density compared to the density of water, which at 4 °C is defined as 1.0000 g/cc. Figure 43 shows that the resin volume per unit weight is inversely related to the resin's specific gravity. In other words, the lower the specific gravity, the greater the number of items that can be produced from a pound. Table 35 lists the specific gravities of Radel® PPSU, Veradel® PESU and Acudel® mod. PPSU resins.

Figure 43: Resin volume varies inversely with specific gravity

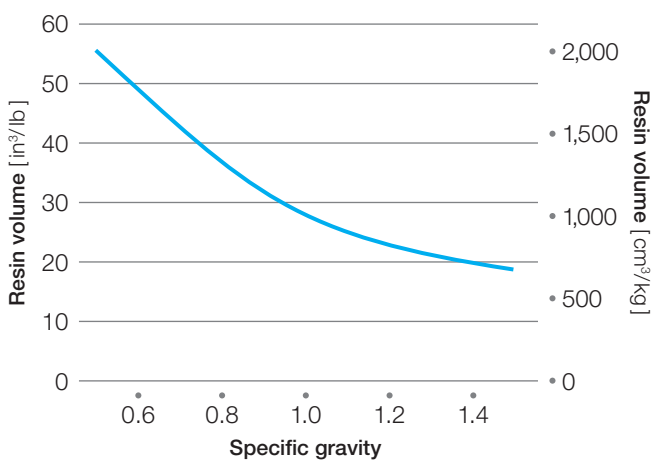

Table 35: Specific gravity of Radel® PPSU, Veradel® PESU and Acudel® mod. PPSU resins

Grade	Material Type	Specific Gravity
Veradel® A-201, A-301	Neat	1.37
Acudel® 22000	Neat	1.28
Radel® R-5000, 5100, 5500, 5800	Neat	1.29
Veradel® AG-320	Glass-filled	1.51
Veradel® AG-330	Glass-filled	1.58
Radel® RG-5030	Glass-filled	1.53

Water Absorption

Most polymers absorb some water from the environment, but they vary significantly in the rate of water absorption and the amount of water absorbed. Figure 44 shows the water absorption versus time curves for Radel® PPSU, Veradel® PESU and Acudel® mod. PPSU resins generated using specimens with a thickness of 3.2 mm (0.125 in.).

Figure 44: Water absorption by immersion at 23 °C (77 °F)

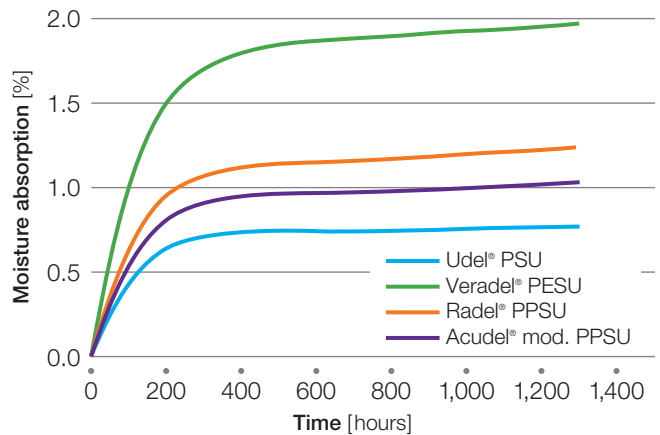

Udel® PSU is well known for its low water absorption, Radel® PPSU resin absorbs a slightly greater amount, and Veradel® PESU resin absorbs somewhat more. The water absorption of Acudel® mod. PPSU resin is higher than that of Udel® PSU resin but less than that of Radel® PPSU resin.

Design Information

This section presents basic design principles and general recommendations that the design engineer may find useful in developing new components. The goal of plastic part design is to achieve a design that meets the physical strength and deformation requirements of the application with a minimum volume of material, without neglecting the effects of stresses caused by assembly, temperature changes, environmental factors, and processing.

Mechanical Design

The use of classical stress and deflection equations provide starting points for part design. Mechanical design calculations for sulfone resins will be similar to those used with any engineering material, except that the physical constants used must reflect the visco-elastic nature of the polymers. The material properties vary with strain rate, temperature, and chemical environment. Therefore the physical constants, like elastic modulus, must be appropriate for the anticipated service conditions.

For example, if the service condition involves enduring load for a long period of time, then the apparent or creep modulus should be used instead of the short-term elastic modulus. Or if the loading is cyclical and long-term, the fatigue strength at the design life will be the limiting factor.

Stress Levels

The initial steps in the design analysis are the determination of the loads to which the part will be subjected and the calculation of the resultant stress and deformation or strain. The loads may be externally applied loads or loads that result from the part being subjected to deformation due to temperature changes or assembly.

An example of an externally applied load might be the weight of medical instruments on a sterilizer tray. Deformation loads might arise when a switch housing is bolted to a base plate, or when the temperature of the assembly increases and the dimensions of the plastic part change more than the metal part to which it is bolted.

Stress-Strain Calculations

To use the classical equations, the following simplifying assumptions are necessary:

- The part can be analyzed as one or more simple structures
- The material can be considered linearly elastic and isotropic
- The load is a single concentrated or distributed static load gradually applied for a short time
- The part has no residual or molded-in stresses

A variety of parts can be analyzed using a beam bending model. Figure 45 lists the equations for maximum stress and deflection for some selected beams. The maximum stress occurs at the surface of the beam furthest from the neutral surface, and is given by:

$$\sigma = \frac{Mc}{I} = \frac{M}{Z}$$

Where:

M = Bending moment, inch pounds

c = Distance from neutral axis, inches

I = Moment of inertia, inches⁴

Z = $\frac{I}{c}$ = Section modulus, inches³

Figure 46 on page 38 gives the cross sectional area (A), the moment of inertia (I), the distance from the neutral axis (c), and the section modulus (Z) for some common cross sections.

Figure 45: Maximum stress and deflection equations

Simply supported beam concentrated load at center

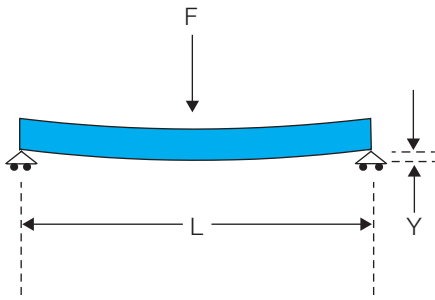

$$\sigma = \frac{FL}{4Z}$$

(at load)

$$Y = \frac{FL^3}{48EI}$$

(at load)

Cantilevered beam (one end fixed) concentrated load at free end

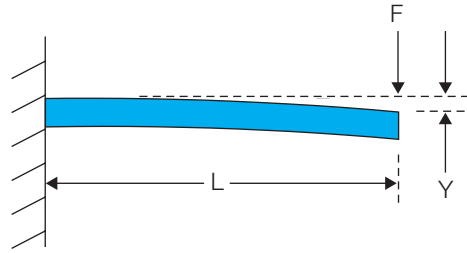

$$\sigma = \frac{FL}{Z}$$

(at support)

$$Y = \frac{FL^3}{3EI}$$

(at load)

Simply supported beam uniformly distributed load

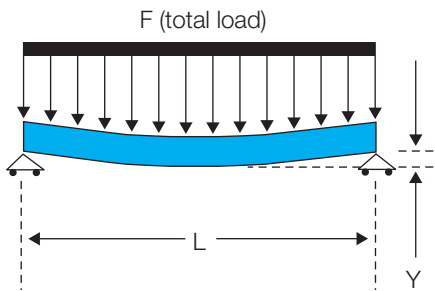

$$\sigma = \frac{FL}{8Z}$$

(at center)

$$Y = \frac{5FL^3}{384EI}$$

(at center)

Cantilevered beam (one end fixed) uniformly distributed load

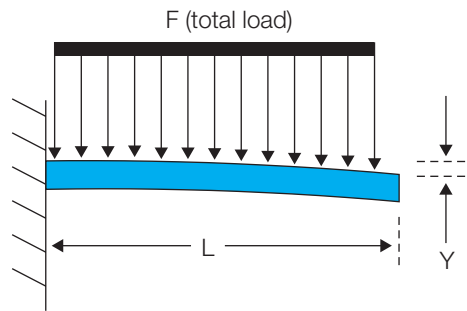

$$\sigma = \frac{FL}{2Z}$$

(at support)

$$Y = \frac{FL^3}{8EI}$$

(at support)

Both ends fixed concentrated load at center

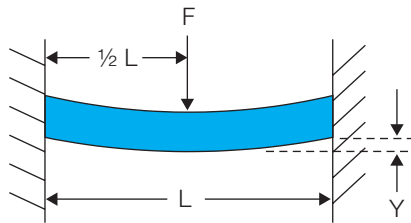

$$\sigma = \frac{FL}{8Z}$$

(at supports)

$$Y = \frac{FL^3}{192EI}$$

(at load)

Both ends fixed uniformly distributed load

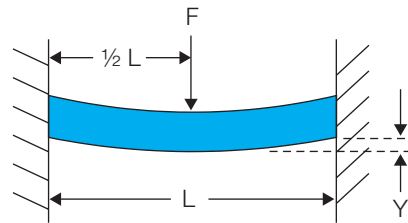

$$\sigma = \frac{FL}{8Z}$$

(at supports)

$$Y = \frac{FL^3}{192EI}$$

(at load)

Figure 46: Area and moment equations for selected cross sections

Rectangular

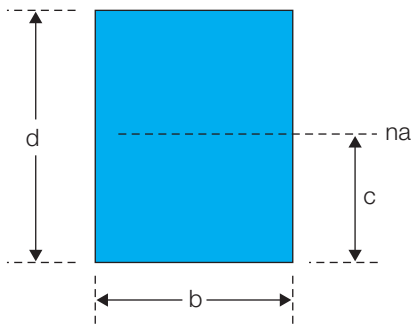

$$A = bd$$

$$c = \frac{d}{2}$$

$$I = \frac{bd^3}{12}$$

$$Z = \frac{bd^2}{6}$$

I-Beam

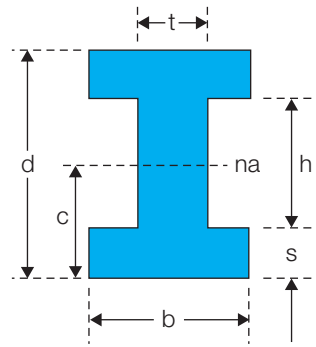

$$A = bd - h(b - t)$$

$$c = \frac{d}{2}$$

$$I = \frac{bd^3 - h^3(b - t)}{12}$$

$$Z = \frac{bd^3 - h^3(b - t)}{6d}$$

Circular

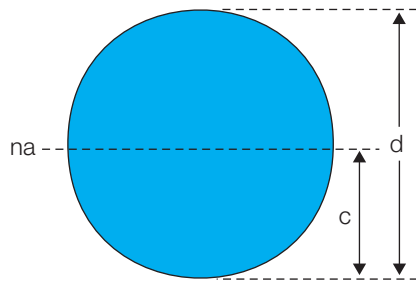

$$A = \frac{\pi d^2}{4}$$

$$c = \frac{d}{2}$$

$$I = \frac{\pi d^4}{64}$$

$$Z = \frac{\pi d^3}{32}$$

H-Beam

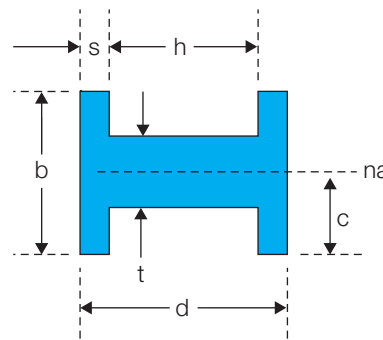

$$A = bd - h(b - t)$$

$$c = \frac{b}{2}$$

$$I = \frac{2sb^3 + ht^3}{12}$$

$$Z = \frac{2sb^3 + ht^3}{6b}$$

Tube

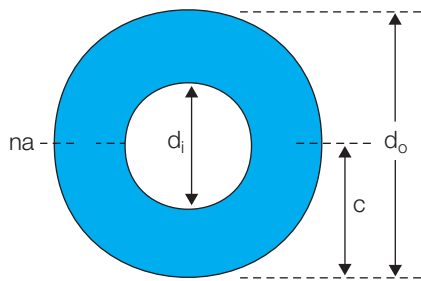

$$A = \frac{\pi (d_o^2 - d_i^2)}{4}$$

$$c = \frac{d_o}{2}$$

$$I = \frac{\pi (d_o^4 - d_i^4)}{64}$$

$$Z = \frac{\pi (d_o^4 - d_i^4)}{32d_o}$$

Hollow rectangular

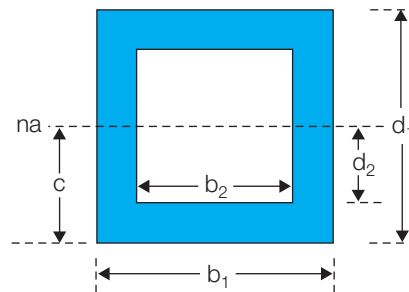

$$A = b_1 d_1 - b_2 d_2$$

$$c = \frac{d_1}{2}$$

$$I = \frac{b_1 d_1^3 - b_2 d_2^3}{12}$$

$$Z = \frac{b_1 d_1^3 - b_2 d_2^3}{6d_1}$$

T-Beam or rib

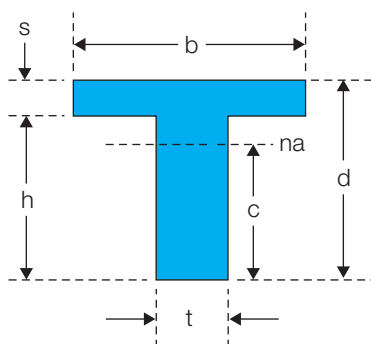

$$A = bs + ht$$

$$c = d - \frac{d^2 t + s^2 (b - t)}{2 (bs + ht)}$$

$$Z = \frac{I}{c}$$

$$I = \frac{tc^3 + b(d - c)^3 - (b - t)(d - c - s)^3}{3}$$

U-Beam

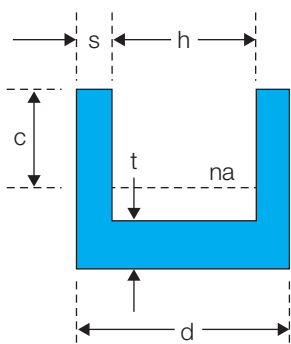

$$A = bd - h(b - t)$$

$$c = b - \frac{2b^2 s + ht^2}{2A}$$

$$I = \frac{2b^3 s + ht^3}{3} - A(b - c)^2$$

$$Z = \frac{I}{c}$$

Design limits

After the designer has calculated the maximum stress level and deflection, he then compares that stress value to the appropriate material property, i.e. tensile, compressive, or shear strength. He then decides whether the design incorporates a sufficient safety factor to be viable or whether the design should be modified by changing wall thickness or incorporating ribs or contours to increase the section modulus.

The term “design allowable” has been coined for an estimate of a material’s strength which incorporates the appropriate safety factors for the intended loading pattern. Table 36 presents the design allowables for short-term intermittent loading. Table 37 provides the design allowable stresses for constant loading where creep is a major design consideration. These Tables do not consider any environmental factors other than temperature. The presence of chemicals may lower the design allowables dramatically.

Table 36: Allowable design stresses* for an intermittent load

Grade	23°C (73°F)	93°C (200°F)	177°C (350°F)
	[MPa (psi)]	[MPa (psi)]	[MPa (psi)]
Veradel® PESU			
A-201, A-301	42 (6,100)	32 (4,570)	18 (2,640)
AG-320	53 (7,710)	40 (5,840)	26 (3,810)
AG-330	63 (9,140)	47 (6,850)	29 (4,160)
Radel® PPSU			
R-5000, 5100, 5500, 5800	36 (5,180)	23 (3,300)	18 (2,540)

* Environmental factors may lower allowable stress levels

Table 37: Allowable design stresses* for a constant load

Grade	23°C (73°F)	93°C (200°F)	177°C (350°F)
	[MPa (psi)]	[MPa (psi)]	[MPa (psi)]
Veradel® PESU			
A-201, A-301	21 (3,000)	16 (2,250)	9 (1,300)
AG-320	26 (3,800)	20 (2,875)	13 (1,875)
AG-330	31 (4,500)	23 (3,375)	14 (2,050)
Radel® PPSU			
R-5000, 5100, 5500, 5800	18 (2,550)	11 (1,625)	9 (1,250)

* Environmental factors may lower allowable stress levels

The design given by the application of the mechanical design equations is useful as a starting point, but some critical factors are simply not considered by this analysis. For example, the impact resistance of a design is directly related to its ability to absorb impact energy without fracture. Increasing wall thickness generally improves the impact resistance of a molded part. However, increased wall thickness could hurt impact resistance by making the part overly stiff and unable to deflect and distribute the impact energy. Therefore, the ability of the design to withstand impact must be checked by impact testing of prototype parts.

Stress concentrations

Stress concentrations may lead to premature failure, particularly under impact or fatigue. Minimizing sharp corners reduces stress concentrations and results in parts with greater structural strength. To avoid stress concentration problems, inside corner radii should be equal to half of the nominal wall thickness. A fillet radius of 0.5 mm (0.020 in.) should be considered minimum.

Outside corners should have a radius equal to the sum of the radius of the inside corner and the wall thickness to maintain a uniform wall thickness. Figure 47 shows the effect of radius on the stress concentration factor.

Figure 47: Stress concentration factor at inside corners

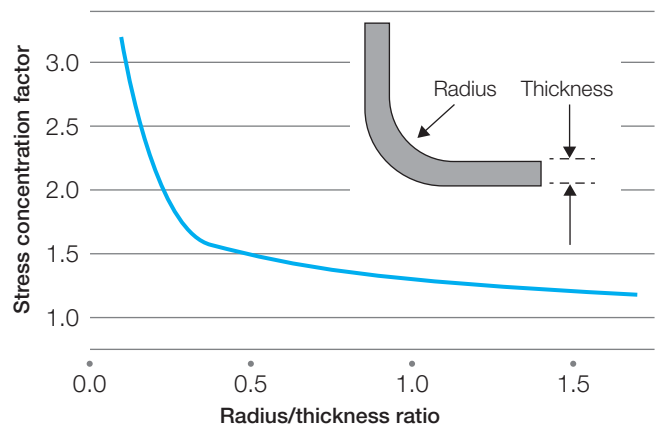

Designing for Injection Molding

Because many of the applications for sulfone resins will be injection molded components, factors which influence moldability must be considered in the part design. These factors include wall thickness and wall thickness transitions, draft, ribs, bosses, and coring.

Wall Thickness

In general, parts should be designed with the thinnest wall that has sufficient structural strength to support the expected loads, keeps deflection within design criteria limits, has adequate flow, and meets flammability and impact requirements. Parts designed in this manner will have the lowest possible weight, the shortest molding cycle, and therefore the lowest cost.

Occasionally, wall thicknesses greater than those required by the mechanical design analysis are required for molding. The flow of sulfone resins, like other thermoplastics, depends upon the wall thickness as well as the mold design and process variables, such as injection rate, mold temperature, melt temperature and injection pressure. The practical limits of wall thickness generally lie between 0.7 mm and 6.5 mm (0.030 in. and 0.250 in.). Wall sections 0.25 mm (0.010 in.) can be molded if flow lengths are short. Specific information regarding flow length versus wall thickness of the various sulfone grades can be found on page 53.

Wall Thickness Variation

While uniform wall thicknesses are ideal, varying wall thickness may be required by structural, appearance, and draft considerations. When changes in wall section thickness are necessary, the designer should consider a gradual transition, such as the 3-to-1 taper ratio shown in Figure 48. Sharp transitions can create problems in appearance and dimensional stability due to cooling rate differentials and turbulent flow.

Figure 48: Wall thickness transition

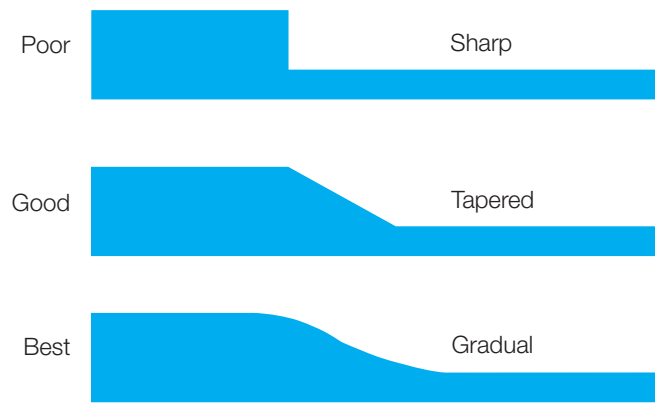

Also, from a structural standpoint, a sharp transition will result in a stress concentration, which may adversely affect part performance under loading or impact.

Draft Angle

To aid in the release of the part from the mold, parts are usually designed with a taper in the direction of mold movement. The taper creates a clearance as soon as the mold begins to move, allowing the part to break free. The taper is commonly referred to as “draft,” and the amount of taper referred to as “draft angle.” The use of draft is illustrated in Figure 49.

Figure 49: Designing for mold release

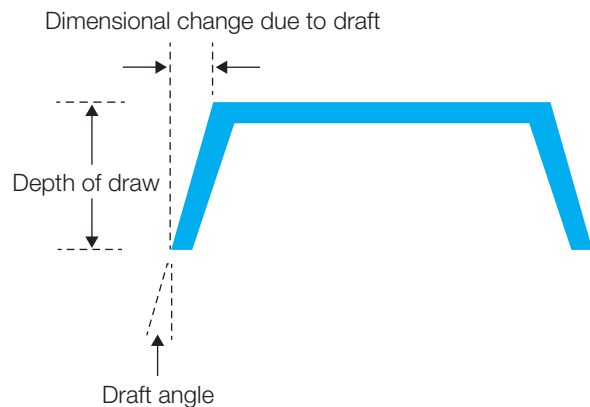

Adequate draft angle should be provided to allow easy part removal from the mold. Generally, the designer should allow a draft angle of 1° to 2° per side for both inside and outside walls for sulfone resins. In some special cases, smaller draft angles have been used with draw polish on the mold surface.

More draft should be used for deep draws or when cores are used. Textured finishes increase draft requirements by a minimum of 1° per side for each 0.025 mm (0.001 in.) of texture depth.

Ribs

The structural stiffness of a part design can be increased with properly designed and located ribs without creating thick walls. Proper rib design allows decreased wall thickness, which in turn saves material and weight, shortens molding cycles and eliminates thick walls, which can cause molding problems like sink marks. Ribs that are correctly positioned may also function as internal runners, assisting material flow during molding.

In general, these guidelines should be followed when designing with ribs. The thickness at the rib base should be equal to one-half the adjacent wall thickness. When ribs are opposite appearance areas, the width should be kept as thin as possible. If there are areas in the molded part where structure is more important than appearance, then ribs are often 75%, or even 100%, of the outside wall thickness. Whenever possible, ribs should be smoothly connected to other structural features such as side walls, bosses, and mounting pads. Ribs need not be constant in height or width, and are often matched to the stress distribution in the part. All ribs should have a minimum of $\frac{1}{2}^\circ$ of draft per side and should have a minimum radius of 0.5 mm (0.020 in.) at the base. Figure 50 shows recommended rib size relationships.

Figure 50: Recommended rib design

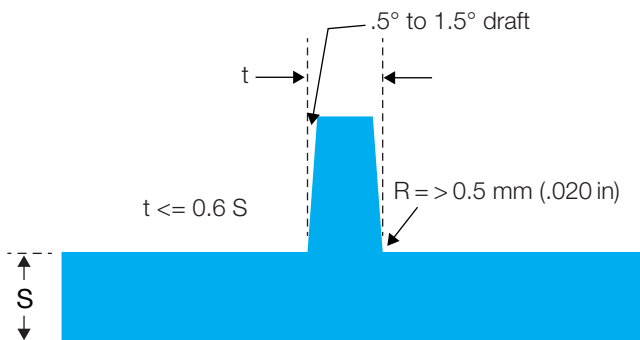

Coring

Proper design should include uniform wall section thickness throughout a part. Heavy sections in a part can extend cycle time, cause sink marks, and increase molded-in stresses.

Heavy sections should be cored to provide uniform wall thickness. For simplicity and economy in injection molds, cores should be parallel to the line of draw of the mold. Cores placed in any other direction usually create the need for some type of side action or manually loaded and unloaded loose cores.

Cores that extend into the cavity are subject to high pressure. For blind cores with diameters greater than 1.6 mm (0.0625 in.), the core lengths should not exceed three times the diameter; blind cores with diameters less than 1.6 mm (0.0625 in.) the core length should not exceed twice the diameter. These recommendations may be doubled for through cores. Draft should be added to all cores and all tooling polished for best ejection.

Bosses

Bosses are protrusions off the nominal wall of a part that will eventually be used as mounting or fastening points. The design of bosses is largely dependent upon their role in a given part. Cored bosses can be used with press fits, self-tapping screws, or ultrasonic inserts. These fasteners exert a variable amount of hoop stress on the wall of the boss.

As a general guideline, the outside diameter of each boss should be twice the inside diameter of the hole, and the wall thickness of each boss should not exceed that of the part. Figure 51 illustrates these guidelines.

Figure 51: Boss design general guidelines

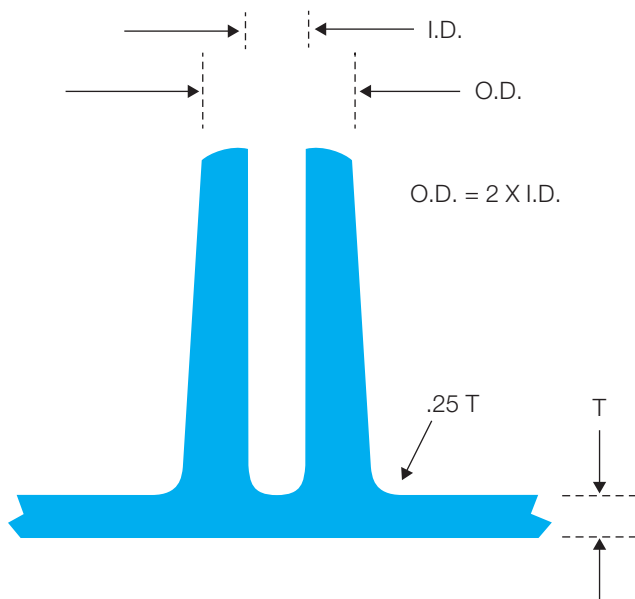

Additional forces imposed on a boss may be transmitted down the boss and into the nominal wall. For this reason, a minimum radius of 25% of the wall thickness is required at the base of the boss to provide strength and reduce stress concentration. A boss can be further strengthened by using gusset-plate supports around the boss, or attaching it to a nearby wall with a properly designed rib. Heavy sections should be avoided to prevent the occurrence of sink marks on the surface of the part.

The fabrication methods used for Radel® PPSU and Acudel® mod. PPSU resins are injection molding, extrusion, and blow molding.

Drying

Radel® PPSU, Acudel® mod. PPSU and Veradel® PESU, should be dried completely prior to melt processing. Although these polymers are hydrolytically stable and not subject to molecular weight degradation, incomplete drying will result in cosmetic defects in the formed part, ranging from surface streaks to severe bubbling. However, such parts may be recovered as regrind.

Pellets of sulfone resin can be dried on trays in a circulating air oven or in a hopper dryer.

Minimum drying times are:

- 2.5 hours at 177 °C (350 °F)
- 4 hours at 150 °C (300 °F)
- 4.5 hours at 135 °C (275 °F)

Drying below 135 °C (275 °F) is not recommended because drying times would be excessive. Dried resin should be handled carefully to prevent resorption of moisture from the atmosphere by using dry containers and covered hoppers.

The recommended maximum moisture content is 500 ppm for injection molding and 100 ppm for extrusion.

Typical drying curves for Radel® PPSU, Acudel® mod. PPSU and Veradel® PESU are shown in Figures 52 through 54.

Figure 52: Drying of Veradel® PESU resin in a circulating air oven

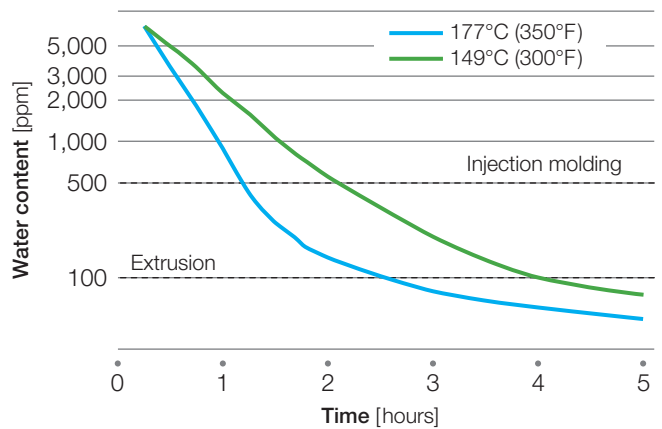

Figure 53: Drying of Radel® PPSU resin in a circulating air oven

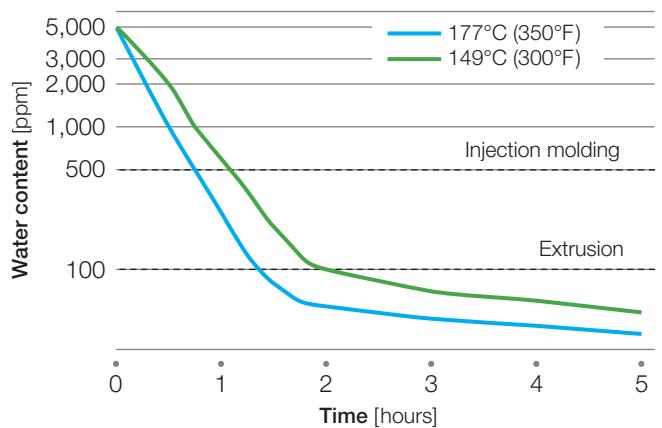
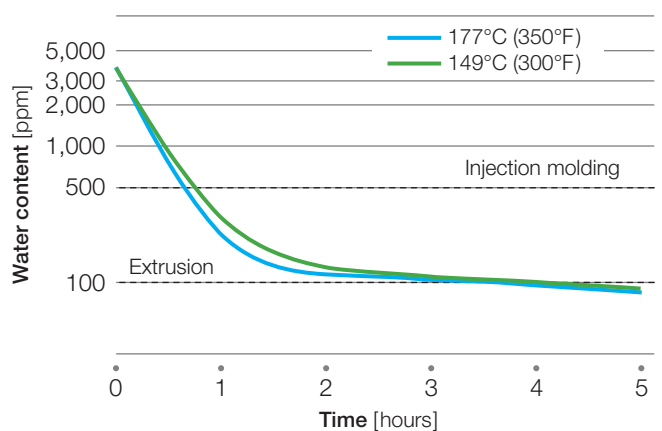

Figure 54: Drying of Acudel® mod. PPSU resin in a circulating air oven



Rheology

To assist the fabricator in the proper design of tools and processing equipment, the rheology of sulfone resins has been measured under a variety of conditions. The viscosity versus shear rate data are shown in Tables 38 and 39.

Table 38: Shear rate – Viscosity data for Radel® PPSU

Radel® PPSU Grade	Temperature [°C (°F)]	Shear Rate [sec ⁻¹]	True Viscosity, Poise
R-5000/ R-5100	340 (644)	30	32,810
		100	30,474
		500	15,293
		1,000	9,465
		3,000	3,803
	360 (680)	30	16,996
		100	16,000
		500	10,244
		1,000	6,780
		3,000	3,084
	380 (716)	30	9,669
		100	9,317
		500	6,723
		1,000	4,864
		3,000	2,446
400 (752)	30	6,808	
	100	6,451	
	500	4,767	
	1,000	3,637	
	3,000	2,000	
R-5800	340 (644)	30	24,224
		100	22,725
		500	12,948
		1,000	8,225
		3,000	3,549
	360 (680)	30	11,972
		100	11,499
		500	8,071
		1,000	5,613
		3,000	2,699
	380 (716)	30	7,165
		100	7,109
		500	5,297
		1,000	3,995
		3,000	2,133
400 (752)	30	4,936	
	100	4,768	
	500	3,661	
	1,000	2,914	
	3,000	1,724	

Table 39: Shear rate – Viscosity data for Veradel® PESU

Veradel® PESU Grade	Temperature [°C (°F)]	Shear Rate [sec ⁻¹]	True Viscosity, Poise	
A-201	345 (653)	100	9,756	
		1,000	4,660	
		10,000	1,496	
	365 (689)	100	6,695	
		1,000	3,198	
		10,000	1,027	
	385 (725)	100	4,595	
		1,000	2,195	
		10,000	705	
	A-301	340 (644)	23	34,686
			104	28,173
			499	16,070
			1,507	7,589
			3,514	3,380
		360 (680)	23	17,982
104			14,864	
499			10,065	
1,507			5,781	
3,514			2,886	
380 (716)		23	12,640	
		104	10,132	
		499	6,905	
		1,507	4,281	
		3,514	2,347	
400 (752)	23	7,449		
	104	6,086		
	499	4,539		
	1,507	3,184		
	3,514	2,100		
AG-330	340 (644)	23	32,271	
		104	25,071	
		499	13,818	
		1,507	7,499	
		3,514	3,373	
	360 (680)	23	19,337	
		104	13,460	
		499	7,933	
		1,507	4,672	
		3,514	2,476	
	380 (716)	23	12,941	
		104	8,511	
		499	5,284	
		1,507	3,346	
		3,514	2,027	
400 (752)	23	9,536		
	104	6,869		
	499	4,241		
	1,507	2,832		
	3,514	1,872		

The rheology data for various Radel® PPSU and Veradel® PESU grades are shown in Figures 55 through 59.

Figure 55: Rheology of Veradel® A-201 resin

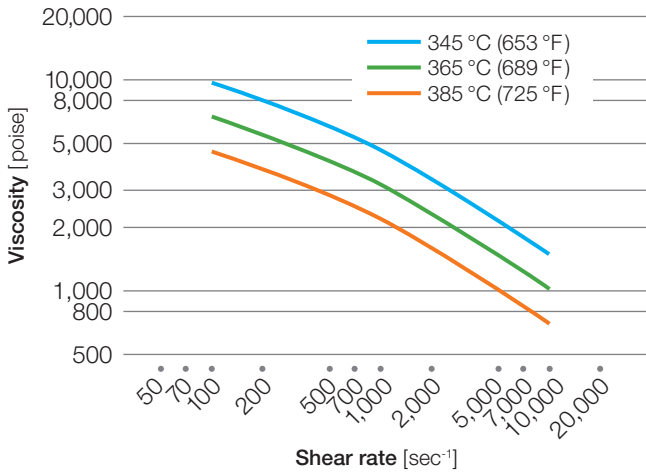

Figure 56: Rheology of Veradel® A-301 resin

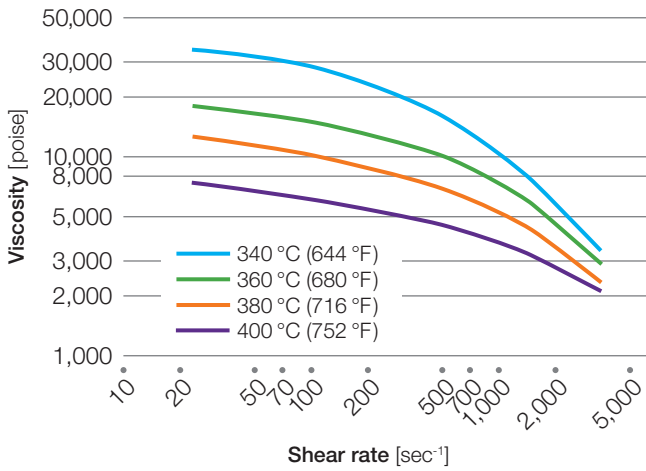

Figure 57: Rheology of Veradel® AG-330 resin

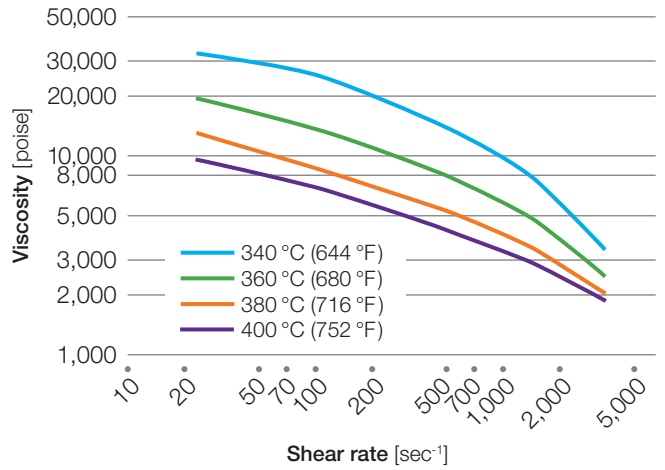

Figure 58: Rheology of Radel® R-5000 resin

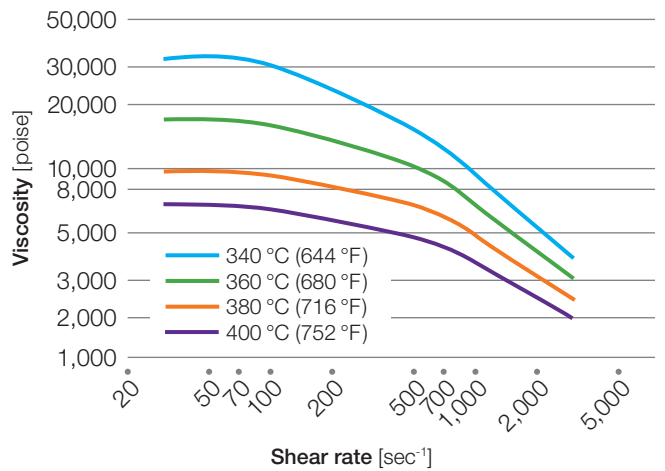
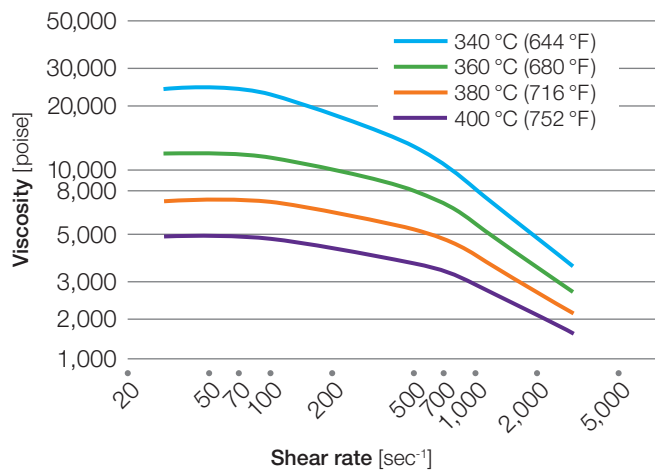

Figure 59: Rheology of Radel® R-5800 resin



Melt Processing Parameters

The increased use of computer modeling for predicting flow and cooling has created a need for certain material constants or parameters. These parameters for Radel® PPSU and Veradel® PESU resins are shown in Table 40 below.

Table 40: Melt processing parameters

Property	Unit	Grade		
		A-201 A-301	AG-330	R-5000
Melt thermal diffusivity	cm ² /s	9.72 · 10 ⁻⁴	9.02 · 10 ⁻⁴	1.66 · 10 ⁻³
Melt specific heat	cal/g·C	0.438	0.408	0.480
Melt density at 10,000 psi	g/cm ³ (lb/in ³)	1.343 (0.0485)	1.596 (0.0577)	1.285 (0.0464)
No flow temperature	°C (°F)	220 (428)	220 (428)	220 (428)
Freezing temperature	°C (°F)	206 (403)	214 (417)	215 (419)
Solid density	g/cm ³ (lb/in ³)	1.355 (0.0489)	1.563 (0.0565)	1.290 (0.0466)
Glass transition temperature				
Onset	°C (°F)	220 (428)	220 (428)	220 (428)
End	°C (°F)	226 (439)	227 (441)	221 (430)

Injection Molding

Injection Molding Equipment

The molding characteristics of Radel® PPSU and Veradel® PESU resins are similar to those of Udel® PSU. Sulfone resins can be readily injection molded with most screw injection machines.

Screw design

The typical general-purpose screw will perform satisfactorily with sulfone resins. A typical screw design for processing the sulfone engineering resins is shown in Figure 60.

Figure 60: Screw design for injection molding

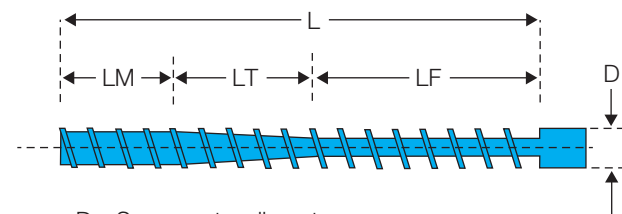

D = Screw outer diameter	
L = Overall screw length	18 – 22 D
LF = Length of feed section	0.5 L
LT = Length of transition section	0.3 L
LM = Length of metering section	0.2 L
CR = Compression ratio	1.8 – 2.4 : 1

Screw tips and check valves

The design of the screw tip and the check valve are important for proper processing. The check or non-return valve keeps the melt from flowing backwards over the screw flights during injection and holding. If no check valve is used, it will be difficult or impossible to maintain a consistent cushion.

The check valve or check ring system must be designed for smooth flow, avoiding dead spots or back pressure. Ball check valves are not recommended. The screw tip should also be streamlined to ensure that the quantity of melt stagnant in front of the screw is minimized.

Nozzles

Open nozzles are preferred to nozzles equipped with shut-off devices. The configuration of the bore of the nozzle should closely correspond to the screw tip.

Molds

Standard guidelines for mold design are appropriate for sulfone resins.

Draft and ejection

In general, the injection molds designed for sulfone resins should have 1° to 2° draft. The contact area of ejector pins or stripper plates should be as large as possible to prevent part deformation or penetration during ejection.

Gates

All conventional gating types, including hot runners, can be used with sulfone resins. Problems may arise with some hot runner designs, which either encourage long residence times or have dead spots where material can accumulate and degrade. Gates must be of adequate size to allow part filling without the use of extremely high injection melt temperatures or pressures. Voids or sink marks may be caused by gates that freeze off before packing is complete.

Venting

Molds for sulfone resins must be vented at the ends of runners and at the position of expected weld lines. The vents should have land lengths of 2 to 3 mm (0.080 to 0.120 in.), with depths up to 0.08 mm (0.003 in.).

Mold temperature control

Controlling the mold temperature is critical to achieving high quality parts. On some especially challenging parts, separate controllers may be required for the mold halves. The temperatures required for molding sulfone resins can be achieved by using a fluid heat transfer system with oil as the fluid, or by using electric heaters.

Fluid heat transfer systems are always preferable to electric heaters. Electric heaters can aid in achieving minimum mold temperatures, but since they don't remove heat from the mold, mold temperatures may rise above the desired temperature, especially when molding large parts.

Machine Settings

Injection molding temperatures

The injection molding melt temperatures recommended for various sulfone resins are listed in Table 41. In general, higher temperatures should not be used because of the risk of thermal degradation. As a fundamental rule, injection molding melt temperatures higher than 395 °C (740 °F) should be avoided.

Mold temperatures

The mold temperature is an important factor in determining the shrinkage, warpage, adherence to tolerances, quality of the molded part finish, and level of molded-in stresses in the part.

The mold temperature for Radel® PPSU, Acudel® mod. PPSU and Veradel® PESU resins is usually set in the range of 120 to 160 °C (250 to 320 °F). The only products that require higher temperatures to achieve an optimum finish are the glass-reinforced Radel® PPSU and Veradel® PESU grades. Table 41 lists the recommended mold temperatures for the individual grades.

Heat losses can be reduced by inserting insulation between the mold and the platen. High quality molded parts require a well-designed system of cooling channels and correct mold temperature settings.

Barrel temperatures

Radel® PPSU, Acudel® mod. PPSU and Veradel® PESU pellets can be melted under mild conditions, and relatively long residence times in the barrel can be tolerated if the temperature settings on the band heaters increase in the direction from the hopper to the nozzle. If residence times are short, the same temperature can be set on all the barrel heaters. At least one band heater (rated at 200 to 300 W) is required for the nozzle, where heat losses to the mold may be severe as a result of radiation and conductivity. These heat losses can be reduced by insulating the nozzle.

The band heater control system should be monitored. For instance, a timely alarm may prevent screw breakage if a heater fails in one of the barrel sections. The feeding of the pellets can often be improved by maintaining the temperature in the vicinity of the hopper at about 80 °C (175 °F).

Residence time in the barrel

The length of time the plastic remains in the plasticizing cylinder has a significant effect on the quality of the injection molding. If it is too short, the pellets will not be sufficiently melted. If it is too long, thermal degradation is likely and is indicated by discoloration, dark streaks, and even burned particles in the molded parts. Frequently, the residence time can be reduced by fitting a smaller plasticizing unit. Acceptable residence times will be obtained if the shot size is 30 to 70 % of the barrel capacity. At the melt temperatures listed in Table 41, these resins all withstand a residence time of 10 to 20 minutes.

Table 41: Molding conditions – starting point

Grade	Melt Temperature [°C (°F)]	Mold Temperature [°C (°F)]	Shrinkage [%]
Radel® R-5000/5100	365–393 (690–740)	150–163 (300–325)	0.6–0.7
Veradel® A-201	365–390 (690–730)	138–160 (280–320)	0.6–0.7
Veradel® A-301	350–390 (660–730)	138–160 (280–320)	0.6–0.7
Veradel® AG-320	360–390 (680–730)	138–160 (280–320)	0.4
Veradel® AG-330	360–390 (680–730)	138–160 (280–320)	0.3
Acudel® 22000	365–393 (690–740)	150–163 (300–325)	0.6–0.7

Molding Process

Feed characteristics

Sulfone polymer pellets can be conveyed smoothly along the barrel and homogeneously plasticized at the recommended temperatures by screws of the design shown in Figure 60 on page 50.

The temperature in the feed section should not be set too high, because the pellets may melt prematurely, resulting in the screw flights becoming choked and bridged over.

Back pressure

Back pressure is usually employed to maintain a constant plasticizing time, to avoid air entrainment, and to improve the homogeneity of the melt. While some back pressure is generally beneficial, back pressure that is too high can result in high frictional heating.

Screw speed

Whenever possible, the screw speed should be set so that the time available for plasticizing during the cycle is fully utilized. In other words, the longer the cycle time, the slower the screw speed. For instance, a screw speed of 60 to 100 rpm often suffices for a 50 mm (2 in.) diameter screw. This is particularly important, when running high melt temperatures to ensure that the melt does not remain stationary for an undesirably long time in the space in front of the screw tip. Low screw speeds also diminish the temperature increase due to friction.

Injection rate and venting

The injection rate used for filling the mold is another important factor in determining the quality of the molded part. Moderate injection speed should be used; It should be rapid enough to achieve melt homogeneity, but slow enough to avoid shear burning. Rapid injection provides uniform solidification and good surface finish, especially with the glass-reinforced grades.

The mold must be designed to allow air to readily escape cavities during the injection phase. If this is not done, rapid compression of the air in the cavity will create high temperatures causing localized overheating and burn marks. In order to eliminate voids, the screw forward time and the holding pressure must be high enough to compensate for the contraction in volume that will occur during cooling.

Gates must be large enough so the polymer does not solidify in their vicinity before the holding time has elapsed. Any plugs formed in or near the gate would prevent the holding pressure from packing the interior of the mold.

Demolding

Radel® PPSU, Acudel® mod. PPSU and Veradel® PESU parts can be readily demolded and do not stick to the walls of the mold, even when they are hot. As a rule, the draft on injection molds for these resins should be 1° to 2°. A somewhat larger draft is required for the glass-reinforced products, because of their lower shrinkage. The area of ejectors or stripper plates should be as large as possible. Ejector pins must not be too thin, or they may press into the parts and deform them during rapid cycling or at high mold temperatures.

Shrinkage

Shrinkage is defined as the difference between the dimensions of the mold and those of the molded part at room temperature. It is primarily a property of the thermoplastic resin and results from the contraction in volume that occurs when the molding compound cools within the mold. Other factors that effect the magnitude of the shrinkage are the geometry of the part, the wall thickness, the size and location of the gates, and the processing parameters. The interaction of all these factors makes it difficult to predict shrinkage exactly, but close estimates of typical values appear in Table 41 on page 47.

Resin Flow Characteristics

One method of characterizing a material's flow is the measurement of the length of flow in a spiral cavity at various thicknesses, temperatures, and molding pressures. Spiral flow data for various grades is shown in Figures 61 through 64.

Figure 61: Spiral flow of Veradel® A-201

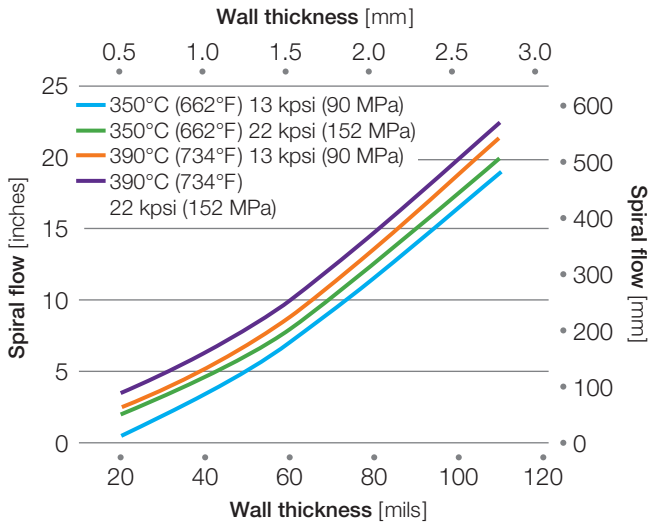

Figure 62: Spiral flow of Veradel® A-301

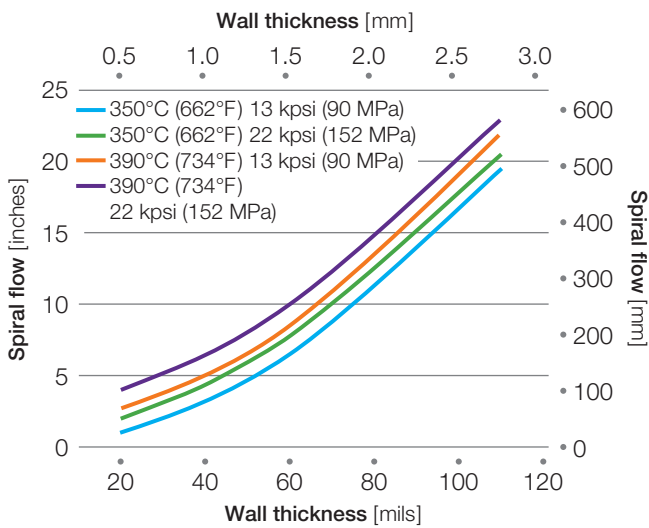
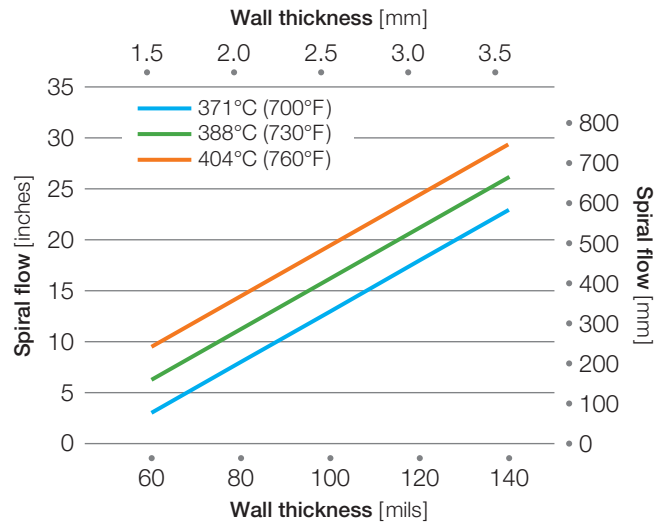
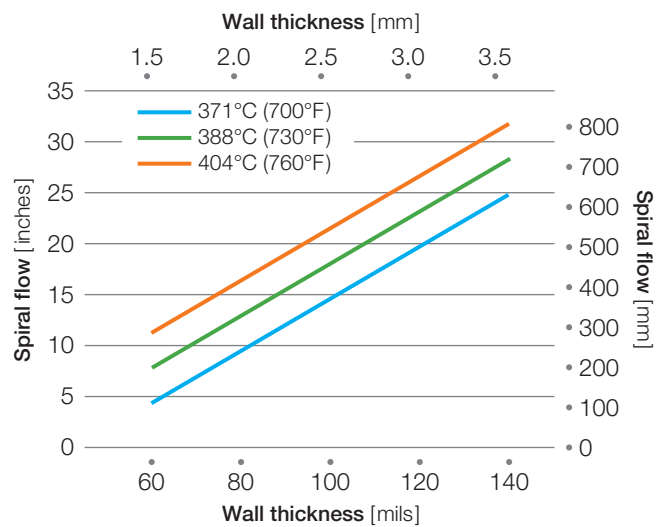

Figure 63: Spiral flow of Radel® R-5000*



* Injection pressure 20 kpsi (138 MPa)

Figure 64: Spiral flow of Radel® R-5800*



* Injection pressure 20 kpsi (138 MPa)

Measuring Residual Stress

When thermoplastics are injection molded, the process induces residual or molded-in stresses in the molded articles. While stresses induced in plastic parts by mechanical and thermal loads may be calculated by conventional means, there is no reliable method for predicting residual stress levels. Many performance parameters are affected by the level of residual stress present in a part. Since these stresses cannot be calculated, it is important to be able to measure them.

A method for measuring the residual stress level in parts molded from unfilled Radel® PPSU, Veradel® PESU and Acudel® mod. PPSU resins has been developed. It involves the exposure of finished parts to chemical reagents which are known to produce cracking or crazing of the material at specific stress levels. Exposure of parts to these reagents under no load conditions allows the quantification of the residual stress levels.

The following Table details the reagents used for this testing and the stress levels at which they are known to cause the material to crack. This information was generated at room temperature at 100% reagent concentration with a one-minute exposure time.

The exposure time required for these reagents to produce cracking at the noted stress level is one minute. This exposure time was employed to facilitate rapid testing and to limit the possibility of errors due to over or under exposure. Exposure for longer time periods produces cracking at stress levels lower than those specified.

To determine the residual stress level of a molded Radel® PPSU or Veradel® PESU part, choose the list appropriate for the grade from Table 41, and follow the procedure shown, starting with the first reagent in the list.

The stress level in the part lies between the stress level shown for the reagent which induces cracking and the one directly above it in Table 42.

Table 42: Residual stress test parameters

Reagents	Minimum Stress Level to Produce Failure [MPa (psi)]
Veradel® PESU	
2-Ethoxyethanol (Cellosolve™)	15 (2,200)
Ethyl Acetate (EA)	8 (1,200)
50%* MEK/50%* EA	6 (800)
Methyl Ethyl Ketone (MEK)	3 (400)
Radel® PPSU	
Ethyl Acetate (EA)	12 (1,750)
Methyl Ethyl Ketone (MEK)	8 (1,200)
5%* N-Methyl pyrrolidone/95%* MEK	6 (800)

* % by volume

Determining stress levels through the use of reagent exposure is approximate in nature. Small differences in the test conditions (ambient temperature, exposure time, or reagent concentration, etc) may cause slight variations in the test results. Results should be within 20% of the actual stress level.

Residual stress levels depend on numerous molding parameters that may be in flux at the time of molding. For this reason, individual samples may exhibit variations in stress levels. Therefore, testing multiple parts is recommended.

The determination of the acceptable molded-in stress level for an individual part should be made from its end use application, in particular, the chemical environment to which the part will be exposed. Radel® PPSU, Acudel® mod. PPSU and Veradel® PESU resins are amorphous thermoplastics that are considered to have good chemical resistance. Parts whose residual stress levels are below 800 psi (5 MPa) may typically be considered well molded.

Health and Safety Considerations

Consult your supplier's Safety Data Sheet before handling the specific reagents selected for testing and follow the manufacturer's instructions for handling precautions.

All testing should be conducted in a ventilated laboratory hood, or in a well ventilated area. The reagents are flammable organic chemicals, and should be stored in closed containers away from open flames, sparks, or locations where elevated temperatures may be expected. Disposal of these materials must be in accordance with applicable federal, state, or local regulations.

Procedure for Residual Stress Determination

- Allow the parts to cool to room temperature then rinse with isopropyl alcohol.
- Expose the part to reagent for one minute, then rinse with water.
- Inspect the part for cracked or crazed regions under strong light. Hairline fractures may be difficult to see.
- If the part has no cracks or crazes, the residual stress level is lower than the stress level shown in table 42 for that reagent. Proceed to the next reagent and repeat steps 2 and 3.

Extrusion

Both Radel® PPSU and Veradel® PESU can be readily extruded on conventional extrusion equipment.

Predrying

Sulfone resins must be thoroughly dried prior to extrusion to prevent bubbles in the extrudate. Resin should be dried until the moisture content is below 100 ppm. Appropriate drying times and temperatures are shown in Figures 52 and 53 on page 43. Hopper drying requires sufficient insulation and minimal system leakage. Inlet air temperature must be high enough and inlet air moisture content low enough for polymer pellets to be maintained above 150 °C (300 °F) in air with a –40 °C (–40 °F) dew point. This condition must be sustained long enough for the polymer moisture content to drop to below 100 ppm.

Extrusion Temperatures

Depending upon the specific extrusion operation, the melt temperature of the extruded stock should be in the range of 343 to 400 °C (650 to 750 °F).

Actual barrel temperature settings of 330 to 370 °C (625 to 700 °F) at the feed end of the extruder and 330 to 370 °C (625 to 700 °F) at the head are recommended for most operations. These temperature settings along the barrel should yield the required extruded stock temperature if maintained uniformly in the range of 340 to 400 °C (650 to 750 °F).

Higher barrel settings may be necessary if a screw with a relatively shallow metering section is used to better control the operation within the pressure and power limitations of the equipment.

Screw Design Recommendations

In general, screws with length-to-diameter ratios from 20:1 to 24:1 are recommended. Compression ratios from 2:1 to 2.5:1 have been shown to give acceptable results. Screw pitch should equal screw diameter, and the transition from feed to metering should be gradual. The transition and metering sections should be longer than the feed section. The transition section should be the longest to provide sufficient time and heat input to adequately soften the resin before trying to pump it. A starting point configuration is 4 flights feed, 14 flights transition, and 6 flights of metering.

Two-stage screws can also be used to allow vacuum venting where optimal compaction of the melt is desired. A two-stage screw design includes a decompression section to allow vacuum venting after the first metering section. The decompression section is then followed by another transition zone and another metering zone, following the design principles described for the single stage screw.

As a rule, screw designs intended for polyolefins will not give acceptable results with sulfone resins.

Die Design

The die heaters must be capable of reaching and maintaining temperatures of 430 °C (800 °F). Since the viscosity of sulfone resins is temperature-sensitive, die temperature must be closely controlled to provide a uniform extrudate.

Streamlined dies should always be used. Streamlining the flow channel and incorporating purge plates (i.e., bleeder plugs) in the ends of sheeting dies eliminate the possibility of hang-up in the die and melt stagnation.

Dies should be capable of operating continuously at pressures up to 240 bar (3,500 psi). Flow channels, die lips, and lands should be highly polished and chromium-plated for optimum extrudate appearance.

Extruded Product Types

Wire

Radel® PPSU and Veradel® PESU resins can be extruded onto wire using a semi-tubing or tubing crosshead die. Wire inlet temperatures should approximate that of the polymer melt. High drawdown of the polymer melt tube can be achieved with Radel® PPSU and Veradel® PESU resins. Vacuum on the crosshead is highly recommended to improve adhesion of the polymer tube to the wire. Coated wire should not be quenched but rather cooled slowly using a mister or water bath.

Film

The high melt strength of sulfone polymers provides excellent drawdown properties for the production of thin film. Slot-cast film possesses high modulus, good impact strength, and good electrical properties over a wide temperature range. The film is heat sealable and can be printed without pre-treatment.

Typical film extrusion conditions for a 64 mm (2.5 in.) extruder are:

- **Die:** Standard film dies of coat hanger design and straight manifold-choker bar design are satisfactory. Die lip openings of 1 to 1.5 mm (0.025 to 0.040 in.) should be used for 0.025 to 0.25 mm (1 to 10 mil) film. Dies must be capable of continuous operation at 240 bar (3,500 psi).
- **Breaker plates/screenpacks:** Breaker plates are not required and can cause “die lines,” but when used in conjunction with a screenpack can result in a consistent, defect-free extrudate. Alternatively, a sleeve can also seal the die adapter to the extruder.
- **Casting roll:** A 215 mm (8.5 in.) diameter roll at 180 °C (350 °F) is required to prevent wrinkling of the film.

Sheet

Standard round and teardrop manifold sheet dies with choker bars are satisfactory. Typically, die openings are 10 to 20% larger than the desired final thickness. In sheet extrusion, the take-off roll temperature must be maintained high enough to prevent curl and to minimize strains in the sheet. Either an “S” wrap technique or straight-through calendaring technique is satisfactory, providing that roll temperatures of 180 to 230 °C (350 to 450 °F) can be obtained. Calendaring also requires that a small bank (melt bead) be maintained at the roll nip.

A power shear has been used to cut the sheet to length for sheet thicknesses up to 2.5 mm (0.100 in.). For greater thicknesses, sawing is recommended.

Pipe and tubing

Radel® PPSU and Veradel® PESU resins can be extruded into pipe and tubing using standard pin and spider assemblies. Control of stock temperature is critical to achieving high-quality extrudate. Stock temperatures of 340 to 370 °C (650 to 700 °F) are suggested.

Sizing plate and vacuum tank methods of dimensional control are satisfactory. For best melt control, the extrusion die should be 70 to 100% larger than the sizing die.

For high-quality extrusion, stress due to processing must be minimized. This is accomplished by minimizing the level of cooling in the vacuum-sizing bath while maintaining dimensional requirements. To this end, a short water bath ($\frac{1}{4}$ to $\frac{1}{5}$ the length of that typically used for polyethylene) is desirable.

Start-Up, Shut-Down, and Purging

Start-up procedure

Feed warm pre-dried resin to the preheated extruder with the screw speed set to 15 to 20 rpm. As soon as the feed section is full, decrease speed to 5 to 10 rpm until material begins to exit the die. Adjust screw speed to desired extrusion rate.

Shut-down procedure

If a shut-down is required during an extrusion run, certain precautions should be taken. It is not good practice to allow resin to sit stagnant in an extruder for prolonged periods of time at extrusion temperatures.

Some decomposition is likely to occur, and it may prove difficult to start again and properly purge the machine.

If the shut-down is of a short duration (two hours or less), purge the extruder with Udel® PSU. Run the extruder dry, and then restart using starve feed. For longer shut-downs, the extruder should be purged with Udel® PSU, and then run dry. The extruder heaters should be turned off and allowed to cool to room temperature. To start-up the next day, turn on the die heaters at least one hour, but preferably two hours, before turning on the extruder heaters. Once the extruder reaches 315 to 343 °C (600 to 650 °F), the screw can be rotated periodically until extrusion temperatures are reached. Start by starve feeding at low screw speeds until material comes out of the die.

Purging

Radel® PPSU, Veradel® PESU and Acudel® mod. PPSU resins can be purged from extrusion processing equipment by a variety of techniques. Because Radel® PPSU resins are tough, stable, high-temperature materials, the most effective purging procedures replace the Radel® PPSU resin with a lower temperature plastic that is more easily removed. The generally recommended purging material is polyethylene, but suitable commercial purging compounds can also be used.

The most effective procedure is a step-wise purge, beginning with a natural polysulfone resin, such as Udel® P-1700, and following with a low-melt-flow, high-density polyethylene. The polysulfone should be fed until it is running clear at the die. The extruder barrel temperatures may be lowered 15 to 25 °C (30 to 50 °F) as the polysulfone replaces the Radel® PPSU, Veradel® PESU or Acudel® mod. PPSU resin. The polysulfone can then be purged by adding polyethylene to the machine while it is at 330 to 340 °C (625 to 650 °F) and running until the extrudate appears to be mainly polyethylene. When that point has been reached, the die, adapter, and breaker plate can be removed and cleaned of the polyethylene as it cools, and machine purging can continue. When no more polysulfone is visible in the extruder purge, the temperature may be safely lowered to 150 °C (300 °F). Various cleaning compounds may then be used, if desired.

An alternative procedure would be to follow the Radel® PPSU, Veradel® PESU or Acudel® mod. PPSU resin directly with the low-melt-index, high-density polyethylene purge. Upon completion of the sulfone resin extrusion, the machine should be run dry of material and the polyethylene introduced and extruded until no Radel® PPSU, Veradel® PESU or Acudel® mod. PPSU compound is evident in the extrudate. The die, adapter, and breaker plate can be removed and cleaned. Polyethylene purging can then be continued until no evidence of sulfone resin is seen in the extrudate, at which point the temperatures can be lowered to 150 °C (300 °F).

When purging is complete and the extruder has been run to an empty condition, the screw can be removed and both the barrel and screw brushed clean. If residual Radel® PPSU resin can not be removed by brushing, it can be burned off using proper care. An alternative technique is soaking the parts in N-Methyl Pyrrolidone (NMP) until the residual resin is softened enough for easy removal.

Secondary Operations

Machining

Radel® PPSU, Veradel® PESU and Acudel® mod. PPSU resins may be machined with normal metal working tools. Because of their high softening temperatures, relatively high cutting speeds can be used without gumming. The inherent toughness of these materials allows deep, smooth cuts to be made without chipping or shattering. If cooling is required, water spray works well.

Drilling and Tapping

Standard high-speed twist drills are recommended. Cutting speeds of 90 m/min (300 ft/min) at feed rates of 0.15 to 0.40 mm/rev (0.005 to 0.015 in./rev) are recommended. Tapping should be done with 2-flute or 3-flute high-speed steel spiral point taps.

Sawing

Standard band saws with blades containing ten teeth per inch (four teeth per cm) operated at 900 to 1,500 m/min (3,000 to 5,000 ft/min) sawing rates work well, but other wood cutting configurations can also be used.

Turning

Conventional variable-speed, metal-turning lathes with either a round-nose or a pointed tool can be used. The recommended configuration for sharp tools is a 3° rake angle, a 10° clearance angle, and a 5° side angle.

Cutting speeds of 150 to 600 m/min (500 to 2000 ft/min) with feed rates from 0.05 to 0.25 mm/rev (0.002 to 0.010 in./rev) can be used.

Milling and Routing

Milling and routing are readily accomplished at high speeds without coolants or lubricants. Tools for aluminum work well. For example, a groove 13 mm (0.5 in.) wide, 2.5 mm (0.100 in.) deep can be end milled at 1,750 rpm with a feed rate of 115 mm/min (4.5 in./min).

Finishing and Decorating

Sulfone resins are an excellent substrate for finishes and virtually any decorative or functional finishing requirement can be met.

Painting

Various colors can be applied to sulfone resin using organic paints and conventional application techniques. Painting may be an economical means of achieving a desired appearance.

Good adhesion with no embrittlement is a critical paint requirement. For proper paint adhesion, removal of foreign matter, such as dirt, oil, grease, and mold release, from the part surface is critical. When contaminants are present, parts should be cleaned first. Properly handled parts may not need any cleaning and can be painted without such treatment.

Although rolling and dipping are sometimes used, spray painting is the usual method of paint application.

The selection of paint is dependent upon the desired decorative finish or functional requirement, and the application technique. Among the coatings used are polyurethane, polyester, epoxy, acrylic, and alkyd.

Depending upon the paint, the cure may be air drying or oven baking. If baking is required, the high thermal resistance of Radel® PPSU, Veradel® PESU and Acudel® mod. PPSU resins allows the use of relatively high oven temperatures.

Electroplating

Electroplated plastic parts are very durable and provide lightweight replacement for die castings and sheet metal. After a special pretreatment to form a conductive surface on the plastic part, it can be put through electroplating processes similar to those used in plating metals.

Hot Stamping

Hot stamping is a one-step, economical process for transferring a high-quality image to a plastic part. A heated die transfers the pattern from the transfer tape to a flat plastic surface. Patterns can vary from lettering to decorative designs in pigmented, wood grain, or metallic finishes.

Sulfone polymers can successfully be hot stamped using either roll-on or vertical action application equipment. The application conditions require no special procedures, and the die temperature, pressure, and dwell time are within conventional ranges.

Printing

Sulfone polymers can be successfully printed by silk-screen and pad-transfer printing techniques. Pad transfer printing offers economies resulting from high speed reproduction. It also allows the reproduction of images in one or more colors, using simultaneous multi-color printing equipment. The silk screening process is primarily used for limited volumes. Although slower than the pad transfer process, silk screening permits the decoration of contoured surfaces, making this method ideal for many molded parts.

Printing inks suitable for use on Radel® PPSU, Veradel® PESU and Acudel® mod. PPSU resin can include a variety of air-dry, plural-component, and ultraviolet-radiation curing inks.

Reinforced grades of Radel® PPSU and Veradel® PESU resin are acceptable for laser marking.

Vacuum Metallizing

Sulfone resins have been successfully vacuum metallized to accept a decorative or functional metallic coating. Although aluminum is the most frequently used coating, other metals such as gold, silver, brass, and copper may also be used.

For most thermoplastics, the first step of the vacuum metallizing process is the application of a base coat of enamel or lacquer to provide leveling of the part surface, which improves the surface brilliance. The base coat also functions as an adhesive, linking the molded part and the metallic coating.

The part is then placed in a vacuum chamber in which a metallic vapor is created and deposited on the part. A protective, clear top coat is then applied over the thin metal layer for abrasion and environmental resistance. The high thermal resistance of Radel® PPSU and Veradel® PESU resins allow the use of durable, abrasion resistant coatings which require high-temperature bake conditions.

The application of metallic surfaces to molded parts tends to emphasize mold defects; therefore mold surfaces should be highly polished.

Cathode Sputtering

The high heat resistance of Radel® PPSU and Veradel® PESU resins allows the use of cathode sputtering. Metals with low vapor pressures like copper and silver are used most frequently. Other acceptable metals are platinum, palladium and gold.

Cathode sputtering permits precise control of the metallic coating thickness and provides improved adhesion of the coating to the part. Both are critical for applications such as sub-miniaturized electrical circuitry.

Flame/Arc Spraying

Flame and arc spraying of metallic coatings may successfully be used with Radel® PPSU and Veradel® PESU resin.

This technique involves the use of pure aluminum, copper, or zinc powder metered into a special spray gun. The metal powder is melted by a flame or electric arc and sprayed onto the part, producing a hard, dense coating.

Assembly and Joining

Ultrasonic Bonding

Ultrasonic bonding is an assembly technique that is used to bond plastic parts together. This technique is very rapid and can be fully automated for high-speed and high-volume production. Ultrasonic bonding requires attention to details like joint design, welding variables, fixturing, and moisture content.

The principle involved in ultrasonic joint design is to concentrate the energy in an initial small contact area. The high frequency vibration melts the material, pressure is maintained when the vibrations stop and the melt solidifies. The bond which is now formed may be as strong as the strength of the original material.

Weldability is dependent upon the concentration of the vibratory energy per unit area. Compared to polycarbonate, Radel® PPSU and Veradel® PESU resins have higher melting temperatures and require more energy to melt the material and achieve flow at the joint.

The basic butt joint with energy director is shown in Figure 65. The V-shaped energy director concentrates the ultrasonic energy to this area, which quickly melts and creates a melt pool as the parts are pressed together. A mating flow channel is preferred in cases where an hermetic seal is desired.

Some additional suggestions to ensure the best results are as follows:

- Welding horn should have a suitable contact area
- Joint/weld area should be located as close as possible to the point where the welding horn will contact the plastic part
- Large mating surfaces and close fit joints should be avoided
- Allow for adequate flow of molten material

Spin Welding

Spin welding is a rapid technique for joining parts with circular joint interfaces. While one part is held fixed, the rotating part contacts it with a specified pressure. Frictional heat is generated at the joint between the surfaces. After the melting occurs, relative motion is halted and the weld is allowed to solidify under pressure.

Figure 65: Energy director design

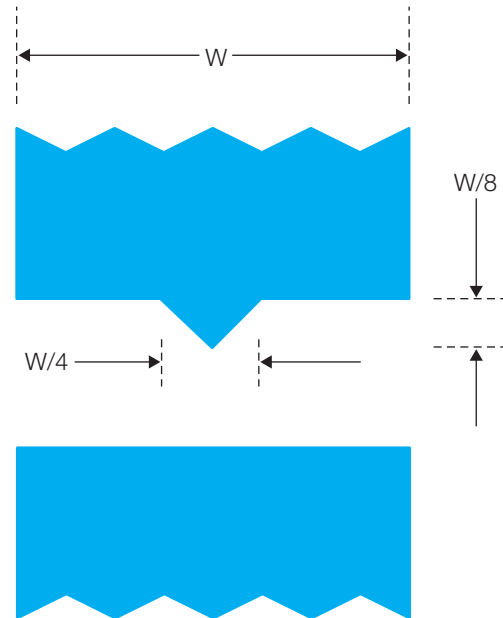

Adhesive Bonding

Parts molded from Radel® PPSU and Veradel® PESU resin can be bonded to other parts molded from these resins, or bonded to other materials using commercially available adhesives. The success of adhesive bonding is very dependent on the end use environmental factors, such as operating temperature, joint design, applied stresses, and chemical exposure.

Adhesives frequently recommended for thermoplastics are epoxies, acrylics, phenolics, polyurethanes, polyesters and vinyl. Specific adhesive recommendations can be obtained from the adhesive suppliers. However, the designer should test the performance of the joint in the actual end use environment.

It is also critical that the surface is free of any contaminants, such as grease, oil, fingerprints and mold release, which can weaken the bond. In some cases, the surfaces of the materials to be bonded must be chemically etched or mechanically roughened to allow the adhesive to gain a firm grip. Clamping pressure should be sufficient to insure good interface contact, but not so high that the parts are deformed or that solvent is forced from the joint.

The joint area should be designed so that the two parts fit precisely together. Figure 66 shows recommended joint designs for adhesive bonding. Parts should be molded with low residual stresses and to accurate dimensions.

Figure 66: Joint designs for adhesive bonding

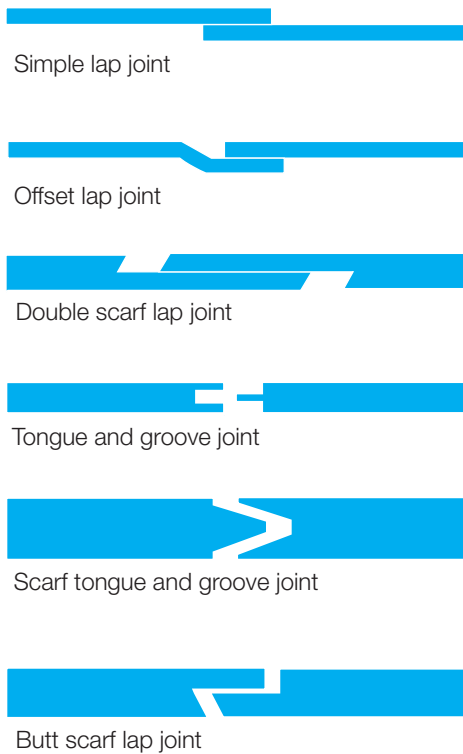

Mechanical Fasteners

Fasteners frequently used with injection molded plastic parts include screws, bolts, nuts, lock washers, and lock nuts. When using metal mechanical fasteners, good design practice should be used to prevent the plastic parts being assembled from becoming over stressed.

The most obvious procedure for preventing a high-stress assembly is to control the tightening of the mechanical fasteners with adjusted torque-limiting drivers. When torque cannot be controlled, as might be the case with field assembly, shoulder screws can limit compression on the plastic part. Other alternatives are the use of flange-head screws, large washers, or shoulder washers. Figure 67 presents some preferred designs when using mechanical fasteners.

Figure 67: Designing for mechanical fasteners

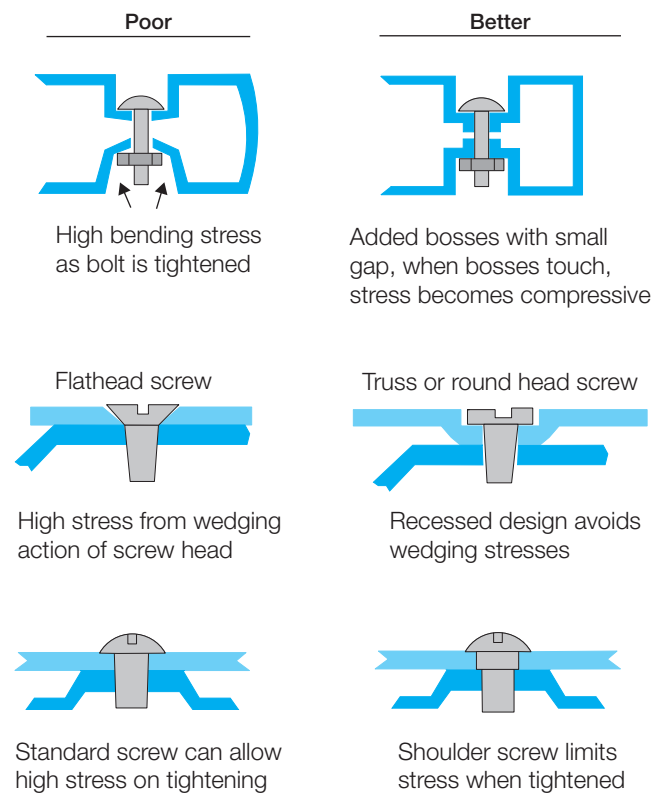

Molded-in threads

With molded-in threads mating male and female threads are molded into the parts to be assembled. Molded internal threads usually require some type of unscrewing or collapsing mechanism in the tool as shown in Figure 68. In some case external threads can be molded by splitting them across the parting line as shown in Figure 69. Molding very fine threads which exceed 28 pitch is usually not practical.

Threaded inserts

Threaded metal inserts provide permanent metallic machine threads in the plastic part. The inserts come in a wide variety of sizes and types. Inserts are usually installed in molded bosses that have an internal diameter designed for the insert. Some inserts are forced into the boss while others are installed by methods that create lower stress and stronger attachments.

A very popular type of insert is the ultrasonic type. This type of insert is installed with the same equipment used for ultrasonic welding. Because ultrasonic welding melts material around the metal insert, the installation is usually strong and relatively free of stress.

Figure 68: Internal threads

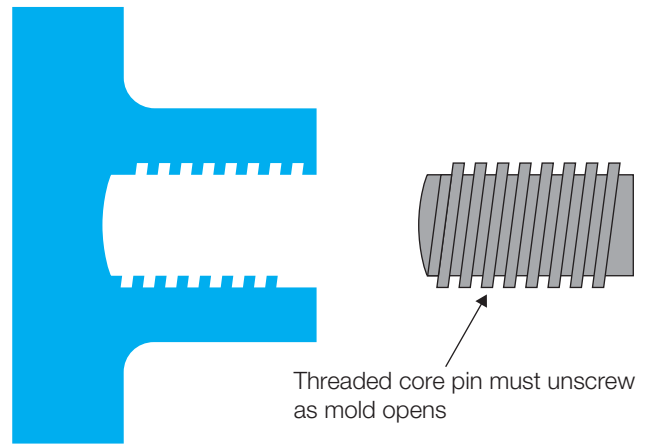
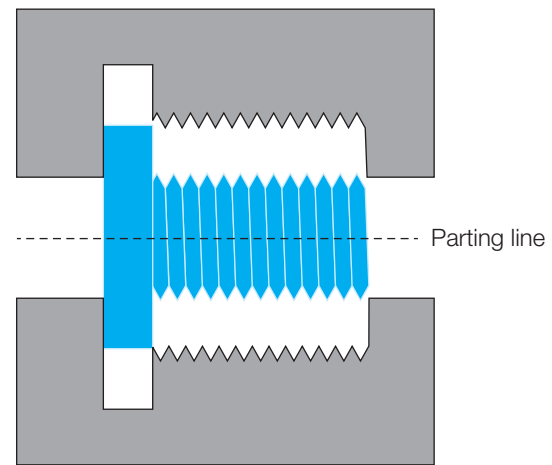

Figure 69: External threads



Besides female threads, inserts can be threaded male styles, locating pins and bushings. The recommendations on installation procedures and boss dimensions can be provided by the insert supplier and resin manufacturer.

Self-tapping screws

Self-tapping screws are suitable for use with Radel® PPSU and Veradel® PESU resins. Self-Tapping screws provide an economical method for joining plastics because they eliminate the need for molding an internal thread or a separate tapping operation.

The major types of self-tapping screws are thread-forming and thread-cutting. Both types of self-tapping threads have advantages and disadvantages, depending on the particular application. Thread-cutting screws physically remove material, like a machine tap, to form the thread. The thread-cutting screws provide lower boss stresses which require lower driving torque and result in lower stripping torque and pullout strength. Thread-forming screws deform the material into which they are driven, forming threads in the plastic part. Thread-forming screws produce higher boss stress, and require higher driving torque, but provide higher stripping torque and pullout strength. The recommended screw type is best determined by prototype testing.

Figure 70 illustrates the basic guidelines for designing with self-tapping screws. These include:

- Use a hole diameter equal to the pitch diameter of the screw for the highest ratio of stripping to driving torque.
- Standard boss diameter recommendation is 2 times the screw diameter. Too thin a boss may crack and no increase in stripping torque may be achieved with thicker bosses.
- Stripping torque increases rapidly with increasing length of engagement and levels off when the engaged length is about 2.5 times the pitch diameter of the screw.
- To avoid stripping or high-stress assemblies, torque-controlled drivers should be used on assembly lines.
- Repeated assembling and disassembling should be avoided when using self-tapping screws. If repeated assembly is required, thread forming screws are recommended.

Figure 70: Boss design for self-tapping screws

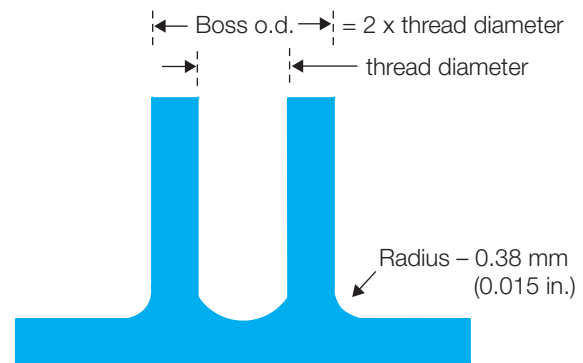

Ultrasonic Inserts

Metal parts can be ultrasonically inserted into parts of plastic as an alternative to molded-in or pressed-in inserts. With proper design, ultrasonic insertion results in lower residual stresses compared to other methods of insertion.

There are several varieties of ultrasonic inserts available and all are very similar in design principle. Pressure and ultrasonic vibration of the inserts melt the material at the metal-plastic interface and drive the insert into a molded or drilled hole. The plastic, melted and displaced by the large diameter of the insert, flows into one or more recesses, solidifies and locks the insert in place.

Figure 71 depicts the recommended insert and boss designs for use with sulfone resin.

Figure 71: Boss design for ultrasonic inserts

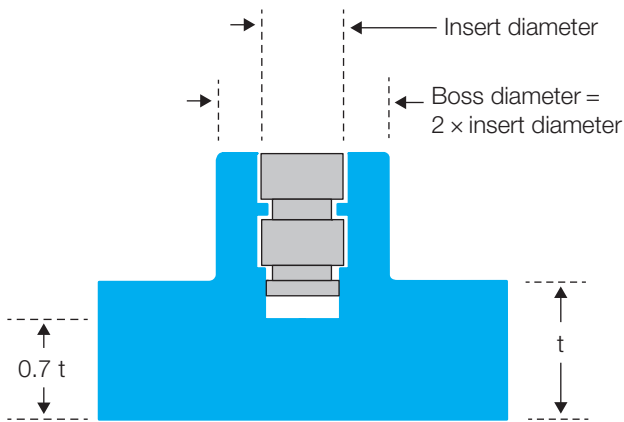

Snap-Fits

The ductility of Radel® PPSU resin combined with its strength make it well suited for snap-fit assembly. In all snap-fit designs, some portion of the molded part must flex like a spring, usually past a designed interference, and return to its unflexed position to create an assembly between two or more parts. The key to snap-fit design is having sufficient holding power without exceeding the elastic or fatigue limits of the material.

The two most common types of cantilever beam snap-fits are straight beam and tapered beam. Figure 72 and Figure 73 show these typical snap-fit designs and the corresponding equations for calculating the maximum strain during assembly. The proportionality constants for a tapered beam design are shown in Figure 74. The design should not have a maximum strain greater than the permissible strain shown in Table 43.

Table 43: Maximum permissible strains for snap-fit designs

Grade	Maximum Permissible Strain
Veradel® A-201	6.0
Veradel® AG-320	1.5
Veradel® AG-330	1.0
Radel® R-5000/5100	6.7

It is recommended that the snap-fit fingers be located away from sharp corners, gates or knitlines. If a large number of assembly cycles is expected, fatigue life could be a consideration and a lower strain limit may be required.

Figure 72: Snap-fit design using straight beam

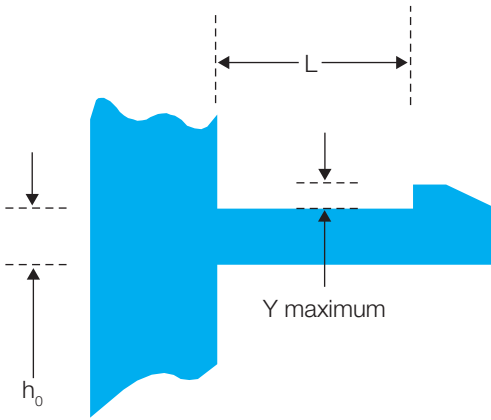

Figure 73: Snap-fit design using tapered beam

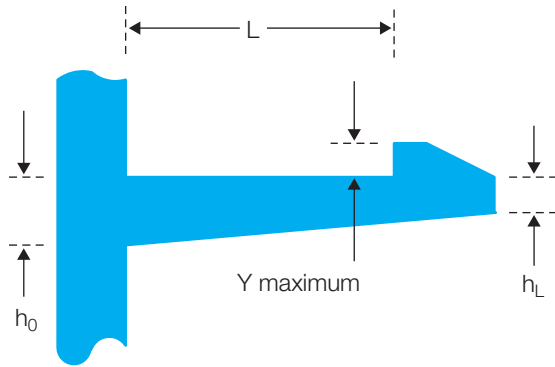
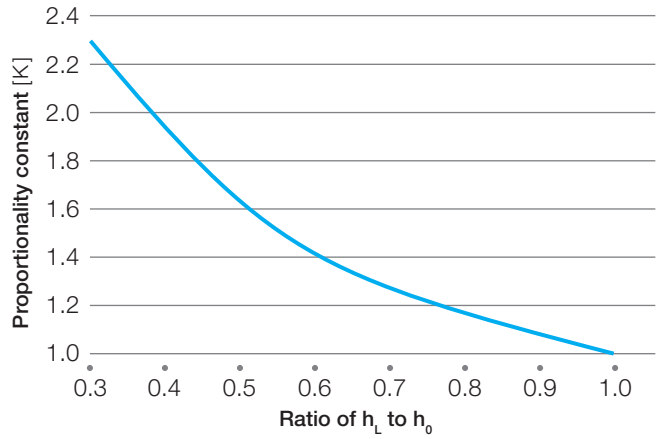

Figure 74: Proportionality constant (K) for tapered beam



Index

A	
Adhesive Bonding	56
Approvals	7
Assembly and Joining	56
B	
Back Pressure	48
Barrel Temperatures	47
Bosses	42
C	
Cathode Sputtering	55
Chemical Resistance	29
Chemical Structure – Property Relationships	4
Chemistry	4
Classification of Thermoplastic Resins	20
Combustion Properties	23
Comparative Tracking Index (CTI)	26
Compressive Properties	15
Coring	41
Creep	18
Creep Modulus	18
D	
Deflection Temperature Under Load	21
Demolding	48
Density	35
Design Information	36
Designing for Injection Molding	40
Design Limits	39
Die Design	51
Dielectric Constant	26
Dielectric Strength	26
Dissipation Factor	26
Draft and Ejection	46
Draft Angle	40
Drilling and Tapping	54
Drying	43
E	
Electrical Properties	26
Electroplating	54
Environmental Resistance	28
Extruded Product Types	52
Extrusion	51
Extrusion Temperatures	51
F	
Fabrication	43
Fatigue	19
Feed Characteristics	48
Film	52
Finishing and Decorating	54
Flame/Arc Spraying	55
Flexural Properties	14
Food Contact	7
French ACS Sanitary Conformity Certificate	8
G	
Gates	46
German Federal Health Office	8
Glass Transition Temperature	20
H	
Health and Safety Considerations	50
Heat Deflection Temperature Comparisons	22
High-Current Arc Ignition (HAI)	26
High-Voltage Arc – Tracking Rate (HVTR)	26
High-Voltage, Low-Current Dry Arc Resistance	26
Hot Stamping	55
Hot Wire Ignition (HWI)	26
Hydrolytic Stability	28
I	
Impact Properties	16
Injection Molding	46
Injection Molding Equipment	46
Injection Molding Temperatures	47
Injection Rate and Venting	48
International Water Contact Standards	8
ISO 10993	7
Isochronous Stress-Strain Curves	19
L	
Long-Term Properties	18
M	
Machine Settings	47
Machining	54
Material Selection	5
Measuring Residual Stress	50
Mechanical Design	36
Mechanical Fasteners	57
Mechanical Property Changes	20
Melt Processing Parameters	46
Milling and Routing	54
Molded-In Threads	58
Molding Process	48
Molds	46
Mold Temperature Control	47
Mold Temperatures	47

N		T	
National Sanitation Foundation	7	Temperature Effects on Modulus	21
Nomenclature	6	Temperature Effects on Tensile Strength	21
Notched Izod	16	Tensile Impact	17
Notch Sensitivity	17	Tensile Properties	9
Nozzles	46	Testing Variables	21
NSF Standard 51: Food Equipment Materials	7	Thermal Aging	25
NSF Standard 61: Drinking Water System Components – Health Effects	7	Thermal Conductivity	23
O		Thermal Expansion Coefficient	22
Oxygen Index	23	Thermal Properties	20
P		Thermal Stability	24
Painting	54	Thermogravimetric Analysis	24
Physical Properties	35	Threaded Inserts	58
Pipe and Tubing	52	Turning	54
Poisson's Ratio	17	Typical Property Tables	9
Predrying	51	U	
Printing	55	UL 94	23
Procedure for Residual Stress Determination	51	UL 746A Short-Term Properties	26
Product Data	5	UL Relative Thermal Index	25
Property Data	9	Ultrasonic Bonding	56
Purging	53	Ultrasonic Inserts	60
R		Underwriters Laboratories	8
Radel Chemical Resistance	29	V	
Radiation Resistance	31	Vacuum Metallizing	55
Residence Time in the Barrel	47	Venting	46
Resin Flow Characteristics	49	Volume Resistivity	26
Rheology	44	W	
Ribs	41	Wall Thickness	40
S		Wall Thickness Variation	40
Sawing	54	Water Absorption	35
Screw Design	46	Water Byelaws Scheme – United Kingdom	8
Screw Design Recommendations	51	Wear Resistance	17
Screw Speed	48	Wire	52
Screw Tips and Check Valves	46		
Secondary Operations	54		
Self-Ignition Temperature	23		
Self-Tapping Screws	59		
Shear Properties	15		
Sheet	52		
Short-Term Properties	9		
Shrinkage	48		
Shut-Down Procedure	53		
Smoke Density	24		
Snap-Fits	60		
Specific Heat	23		
Spin Welding	56		
Start-Up Procedure	53		
Start-Up, Shut-Down, and Purging	53		
Steam Sterilization Analysis	28		
Stress Concentrations	39		
Stress Crack Resistance	31		
Stress Levels	36		
Stress-Strain Calculations	36		
Stress-Strain Curves	12		



Specialty Polymers

Worldwide Headquarters

SpecialtyPolymers.EMEA@solvay.com

Viale Lombardia, 20
20021 Bollate (MI), Italy

Americas Headquarters

SpecialtyPolymers.Americas@solvay.com

4500 McGinnis Ferry Road
Alpharetta, GA 30005, USA

Asia Headquarters

SpecialtyPolymers.Asia@solvay.com

No.3966 Jindu Road
Shanghai, China 201108

www.solvay.com

Safety Data Sheets (SDS) are available by emailing us or contacting your sales representative. Always consult the appropriate SDS before using any of our products.

Neither Solvay Specialty Polymers nor any of its affiliates makes any warranty, express or implied, including merchantability or fitness for use, or accepts any liability in connection with this product, related information or its use. Some applications of which Solvay's products may be proposed to be used are regulated or restricted by applicable laws and regulations or by national or international standards and in some cases by Solvay's recommendation, including applications of food/feed, water treatment, medical, pharmaceuticals, and personal care. Only products designated as part of the Solviva® family of biomaterials may be considered as candidates for use in implantable medical devices. The user alone must finally determine suitability of any information or products for any contemplated use in compliance with applicable law, the manner of use and whether any patents are infringed. The information and the products are for use by technically skilled persons at their own discretion and risk and does not relate to the use of this product in combination with any other substance or any other process. This is not a license under any patent or other proprietary right.

All trademarks and registered trademarks are property of the companies that comprise the Solvay Group or their respective owners.
© 2014, Solvay Specialty Polymers. All rights reserved. D 2004 | R 07/2015 | Version 6.0 Brochure Design by www.ahlersheinel.com